



NEWHUABAO (Hardware) Industrial Co., Ltd.

E-PAI Metal products Co.Ltd.

EPAINOX Technology (GD) Manufactures Co., Ltd.

Factory Add: Workshop in Building 6A, Yuehai Intelligent Manufacturing Industrial Park, West Industrial Avenue, Songxia Industrial Zone, Nanhai District, Foshan City, Guangdong, China

- 🔗 E-PAI Stainless Steel Pipe
- 🔗 E-PAI Bathroom Hardware
- 🔗 E-PAI Architectural Hardware
- 🔗 E-PAI Safely Grab Bar
- 🔗 E-PAI Door Pull Handle
- 🔗 E-PAI Glass Fitting Hardware
- 🔗 E-PAI Locking Ladder Pulls
- 🔗 E-PAI Fence Spgnot
- 🔗 E-PAI Door Handle
- 🔗 E-PAI Handrail
- 🔗 E-PAI INOX Hardware
- 🔗 E-PAI Stair Railing
- 🔗 E-PAI Pipe Fitting Hardware

Tel: +86-757-85751892 85751893 Fax: +86-757-85751891
 P.C: 528247
 E-mail: manager@epai-hardware.com
 Https: // www.epaicn.com www.epai-hardware.com
 Contact person: James Lam
 phone: +86-132 2672 5491

Hardware.Project

www.epai-hardware.com



E-PAI keeps close paces with times regarding the development of new varieties. This manual cannot fully express all the details. The pictures and copyright of the catalogue are owned E-PAI. Without written permission, any re-photographing, plagiarizing, copy etc will be considered to be an infringement, and will be charged with law responsibility

91

ARCH

Architectural Hardware



Door Pull Handle
Locking Ladder Pulls

SERIES
HANDLE
DOOR PULL

Safely Grab Bar
Bathroom Hardware

SERIES
BATHROOM
HANDLE LOCK

Stainless Steel Pipe
Pipe Fitting Hardware

SERIES
PIPE
STAINLESS STEEL

Handrail
Fence Spgnot
Hardware
Glass Fitting
Stair Railing



28⁺ Years

OF PRODUCTION EXPERIENCE

PHILOSOPHY OF EPAI —

THE PURSUIT OF FRESH BEAUTY

INDUSTRY LEADER

AHEAD OF ARTWARE BUILDING A DREAM WITH JOINT EFFORTS

EPAI pursues excellence,

All the products are revealed by a group of people who are pursuing the ingenuity of stainless steel building materials, professionalism, concentration, and dedication to practice the Chinese dream of achieving the world's leading stainless steel architectural materials.

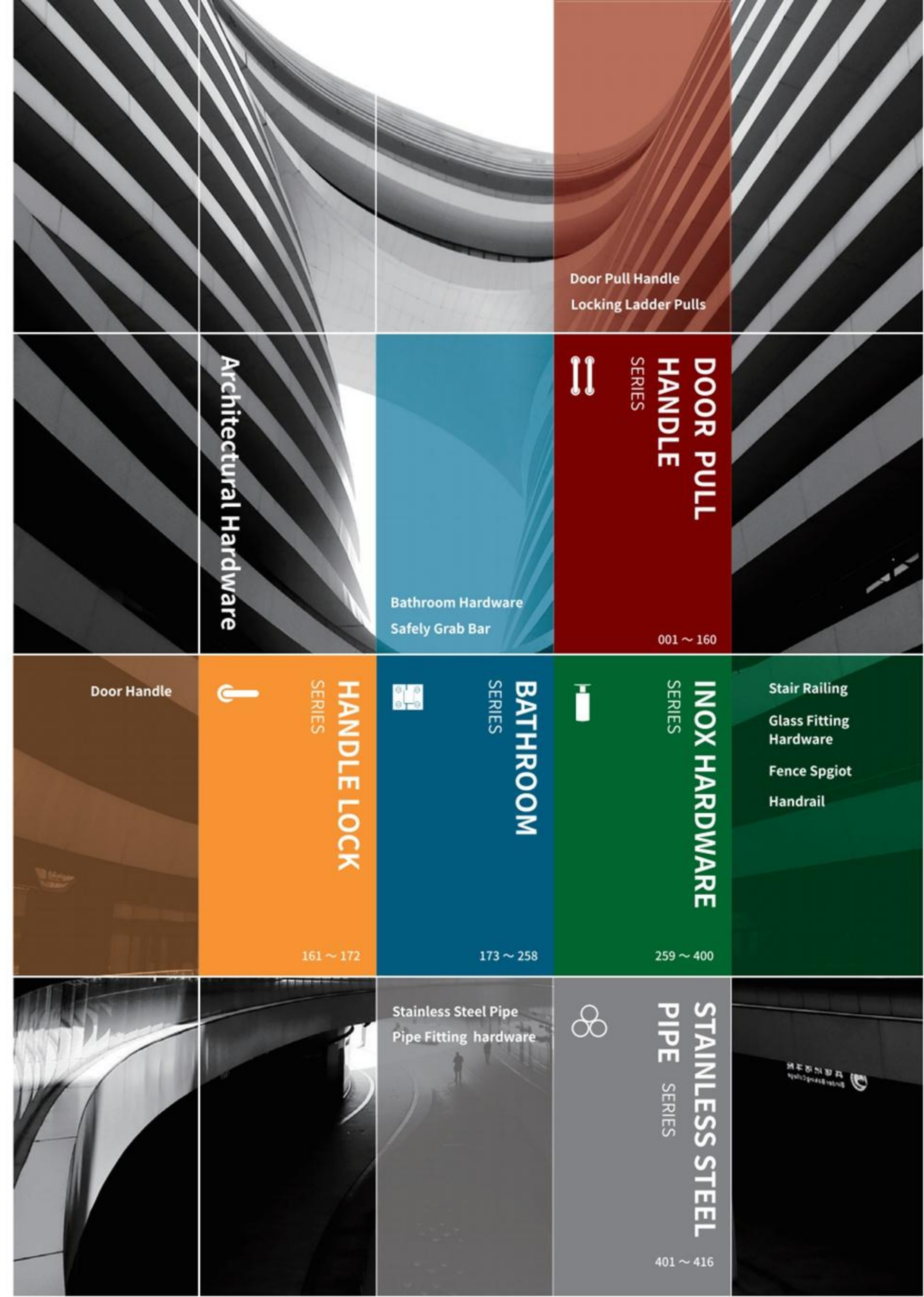

EP LEVER HANDLE

Door lever handle

Altruism pai

品派



Elegant style classic and simple life



**Product
caption**

EPAI series door lock handle is one of the high-end architectural decoration hardware accessories produced by Newhuabao Hardware Decoration Products Factory. The product has beautiful appearance and is suitable for wooden doors and aluminum alloy doors of hotels, shopping malls, office buildings and homes.

**Function
and
advantage**

- According to ISO901:2000 version of the international quality system for product quality process control, in line with the country The GB/9301-88 standard better guarantees the stability of product quality.
- The 304 stainless steel used in the products is produced using 1.2m thick-walled tubes, which meets national standards. Better guarantee the strength of the product.
- All door lock handles can be installed on wooden doors and framed doors to suit all aspects of application.
- The surface of all door lock handles can be treated with high quality for mirror, sand, semi-sand, and titanium.



FINE WORK
LOCK TO SAFETY

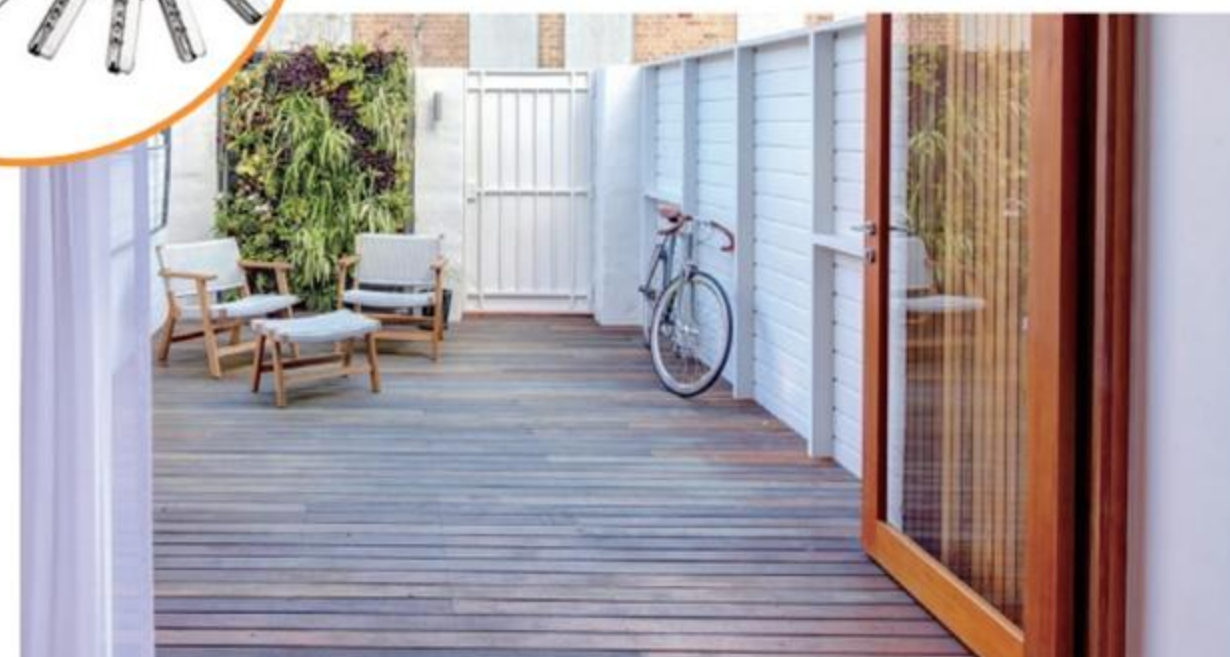

FINISHING DETAIL SAMPLES

表面处理样式



E-pai 一派備有6種常用表面處理顏色提供給設計師及專業客戶選擇。除了傳統的拉絲、亮光、分色、PVD金、拉絲金外，還有高貴典雅的玫瑰金供品位高尚人士選擇。

Epai gives designers and customers 6 different options of finish to choose. Except for the traditional satin, polished, satin+polished, polished PVD, Satin PVD, we also has the elegant rose PVD finish for the noble people's choice.

E-pai 一派提供的表面處理給予您長久有效的使用保障，拉絲、亮光、分色均為現代工藝全自動打磨而成，確保產品始終如一的品質標準。

The finish provided by EPAI give our customer long time guarantee. The satin, polished, and satin+polished finish with modern technology are polished automatically to make sure the consistent quality standard.

Cylinder series 鎖芯系列

BK鎖芯的耐久性為最高等級 (GRADE 6) ;
符合最新歐洲標準EN1303: 2006;
防腐測試96小時。
BK Cylinders endurance is in the best grade(Grade6),
which up to Europe EN1303:2006 standards.
Rusting test for 96 hours.

四級總鑰匙系統: GGNK配大號鑰匙
4 different Master key system, with GGNK large key.

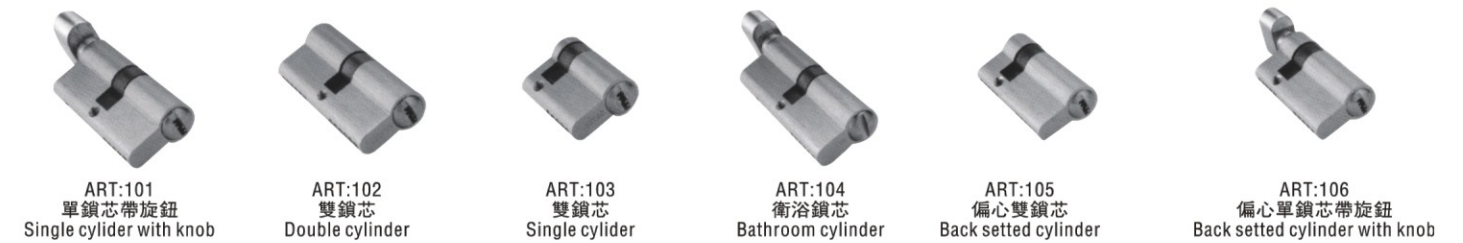
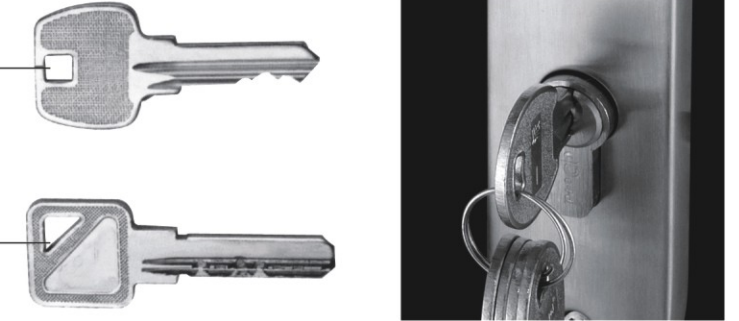

BK鎖芯(BK Cylinder)			
符合標準(Standard)	歐洲標準EN1303(Europe EN1303 standard)		
材質及特點 (material & Featuress)	鎖芯長度超過68mm,標配6彈子鎖芯, 選配5彈子鎖芯(The length of cylinder is longer than 68mm)		
	Schlage C鑰匙槽 (Schlage C key hole)		
	鎖芯材質黃銅 (The material of cylinder is made by brass)		
總鑰匙系統 (Master Key System)	標配3把黃銅鑰匙, 電腦鑰匙3把 (Standard cylinder with 3 keys, "Computer based cylinder" with 5 keys)		
	四級總鑰匙系統, 可將美式插芯鎖, 簡式鎖納入同一總鑰匙系統 (4 different Master key system, can combine US and traditional cylinder into one Master Key)		
表面處理(Finishing)	光亮度鉻, 緞紋鍍鎳 (Shiny Chromium plated with Nickel Plated stripes)		
尺寸(mm) (Measurement)	功能描述(Function)	型號(Style NO.)	長度(Length)
	單鎖芯帶旋鈕(Single cylinder with knob)	ART:101	60 65 70 75 80 90
	雙鎖芯(Double cylinder)	ART:102	60 65 70 75 80 90
	雙鎖芯(Double cylinder)	ART:103	40 42.5 47.5 50
	衛浴鎖芯(Bathroom cylinder)	ART:104	60 65 70 75
	偏心雙鎖芯(Back setted cylinder)	ART:105	根據實際實際情況定制(Depends on different situation)
	偏心單鎖芯帶旋鈕 (Back setted cylinder With knob)	ART:106	根據實際實際情況定制(Depends on different situation)

INTRODUCTION

of mortise function / 锁体功能说明

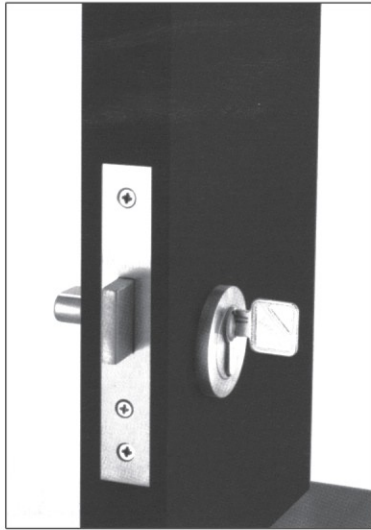

BK45A 單杆通道鎖
BK45A Dead Lock

根據選擇的鎖芯不同，可在門的單側或雙側用鑰匙的鎖芯旋鈕控制方舌的伸出與縮回。
According to the cylinder, either twist the lever or the key to control the latch.



BK45B 斜舌通道鎖
BK45B Latch Lock

始終通過轉動兩側的把手縮回斜舌。
Twist either side of the lever to control the latch.



BK4585 單杆雙舌鎖
BK4585 Sash Lock

門把手僅控制斜舌。根據選擇的鎖芯不同，可在門的單側或雙側控制方舌的伸出與縮回。鎖芯也能控制斜舌。
Lever handle just for controlling the latch, according to the cylinder can be one side or both side to control the lock and the latch.

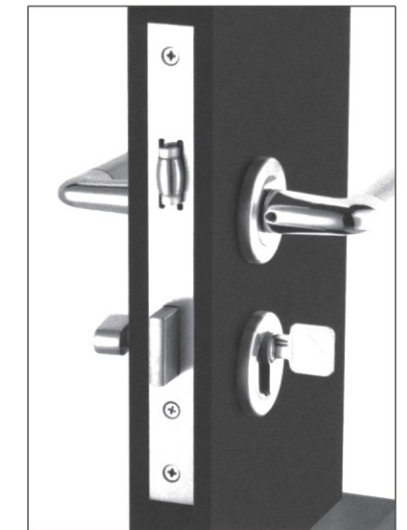

BK4585 滾珠圓舌鎖
BK4585 Roller Ball Lock

門把手僅控制斜舌。根據選擇的鎖芯不同，可在門的單側或雙側控制方舌的伸出與縮回。鎖芯也能控制斜舌。
Lever handle just for controlling the latch, according to the cylinder can be one side or both side to control the lock and the latch.



BK55B
BK55B

始終通過轉動兩側的把手縮回斜舌。
Twist either side of the lever to control the latch.

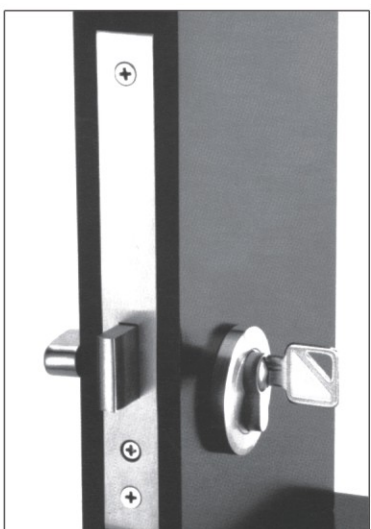

BK4585 單栓舌鎖
BK4585 Dead Lock

根據選擇的鎖芯不同，可在門的單側或雙側用鑰匙的鎖芯旋鈕控制方舌的伸出與縮回。
According to the cylinder, either twist the lever or the key to control the latch.



BK4585 單鋒舌鎖
BK4585 Latch Lock

始終通過轉動兩側的把手縮回斜舌。
Twist either side of the lever to control the latch.



BK4585 單杆衛浴鎖
BK4585 Privacy Lock

門把手僅控制斜舌。門內把手配置旋鈕蓋或旋鈕長面板，轉動旋鈕伸出或縮回方舌。門外把手配置帶指示標記和緊急釋放裝置的指示蓋或帶指示長面板，并用8mm的軸運動方舌，不使用鎖芯。
Lever handle just for controlling the latch, inside handle with twistable cover to control the lock, outside with an indicator, without cylinder just usage of M8 spindle to control the lock.



BK4585 衛浴鎖
BK4585 Privacy Lock

門把手僅控制斜舌。門內把手配置旋鈕蓋或旋鈕長面板，轉動旋鈕伸出或縮回方舌。門外把手配置帶指示標記和緊急釋放裝置的指示蓋或帶指示長面板，并用8mm的軸運動方舌，不使用鎖芯。
Lever handle just for controlling the latch, inside handle with twistable cover to control the lock, outside with an indicator, without cylinder just usage of M8 spindle to control the lock.

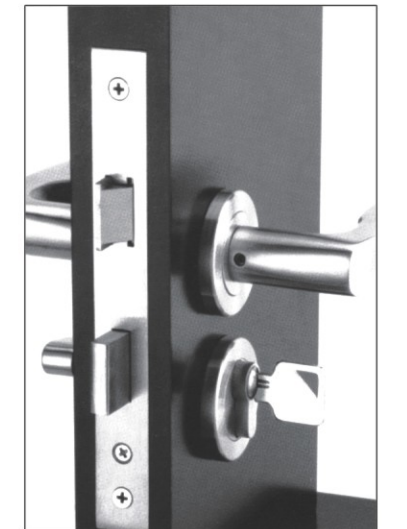

BK5572 雙舌鎖
BK5572 Sash Lock

門把手僅控制斜舌。根據選擇的鎖芯不同，可在門的單側或雙側控制方舌的伸出與縮回。鎖芯也能控制斜舌。
Lever Handle just for controlling the latch, according to the cylinder can be one side or both side to control the lock and the latch.

FITTING INSTRUCTION

安装说明

把手连分圈及锁眼盖
Lever On Rose With Escutcheon

结构特徵:

把手部分由不锈钢精密铸造加工或机加工而成;把手护环,面板由两部分组成:内部厚度为1.2mm的钢制镀锌衬板;外部是厚度为0.8mm不锈钢冲压外盖。

该系列把手造型多样,富于变幻,充分体现了设计师的艺术构思,最大程度上满足了用户多样化和个性化的需求。

同于该系列把手材质坚硬,造型多变,比例适中,多作为装饰性把手,广泛应用于高档写字楼、商业高设计施、别墅、公寓及精品住宅之中。

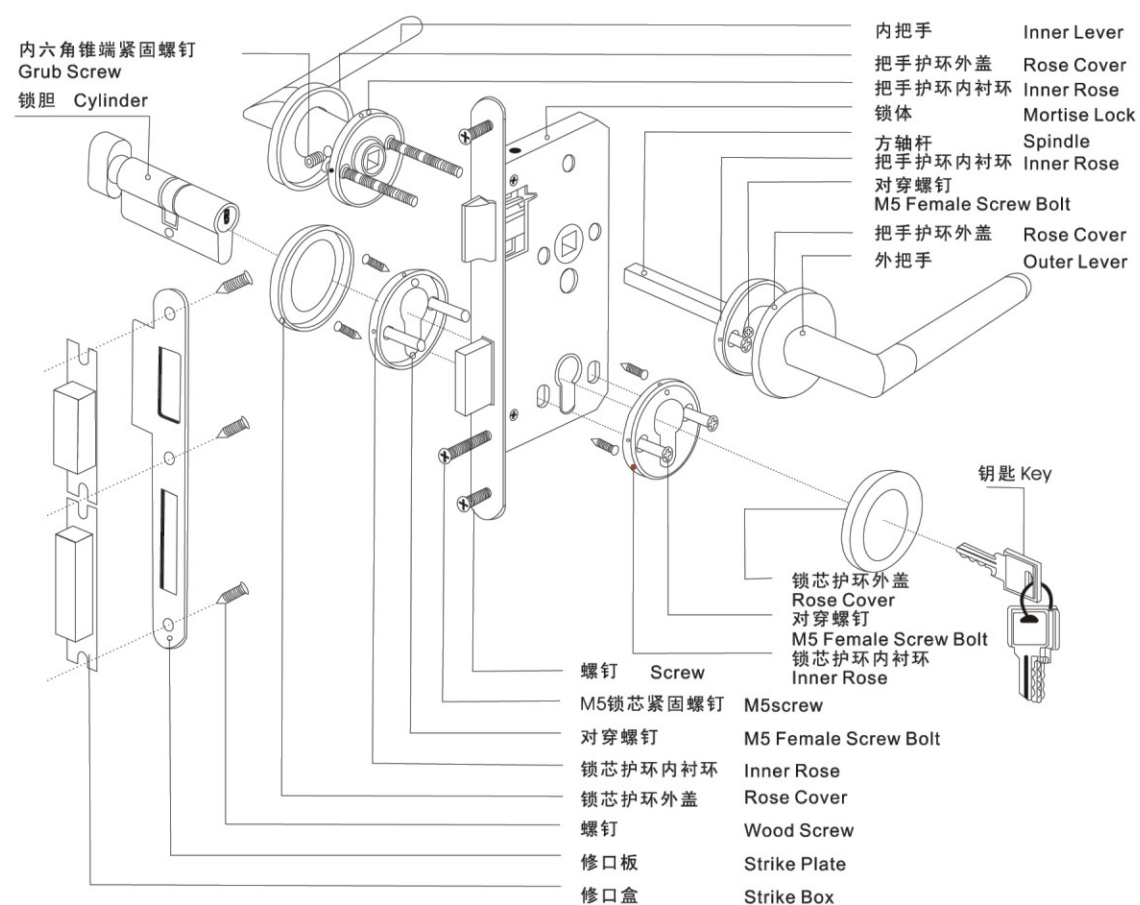

Features:

Lever handle can fit with either rose system or backplate system. For the rosette, 1.2mm of zinc plated stainless steel material is used on the inner rose while 0.8mm thickness of outer rose is formed by stamping which is made of stain less steel.

Variety styles and creative designs fulfilling different demand of customer such as public usage, commercial facilities, apartment and villas decoration, BESTKO chooses stainless steel to be material of door furniture as if is an excellent material for architectural hardware since its surface is extremely resistant to corrosion, knocks, scratches and abrasion, The durability of the material is such that under normal usage the appearance and function of stainless steel door furniture will remain like new, for life.

装配说明
Fitting Instruction

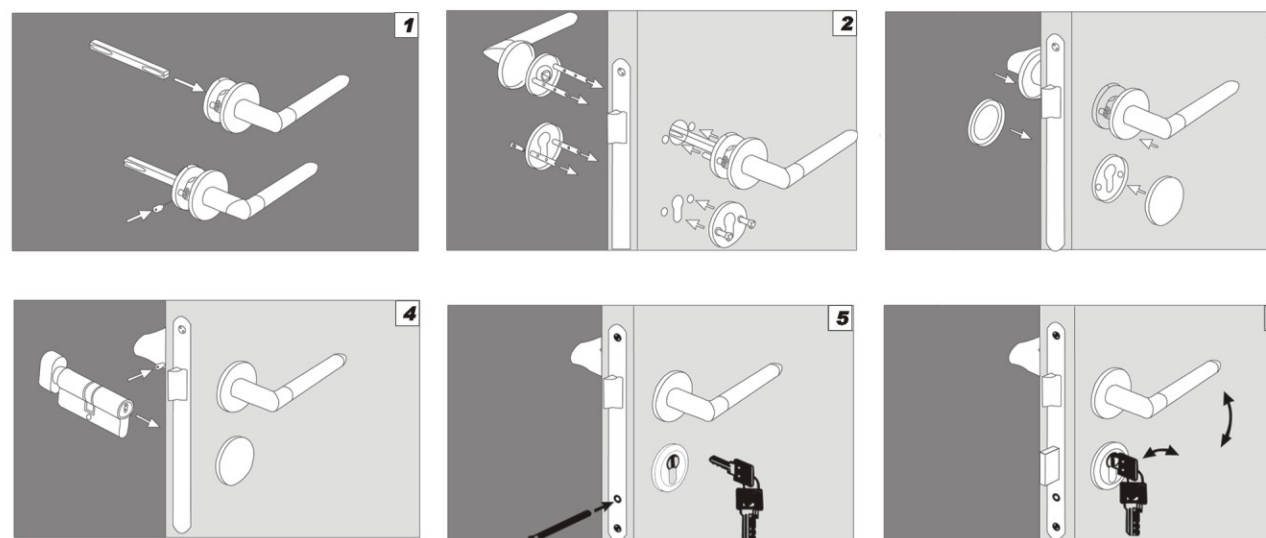
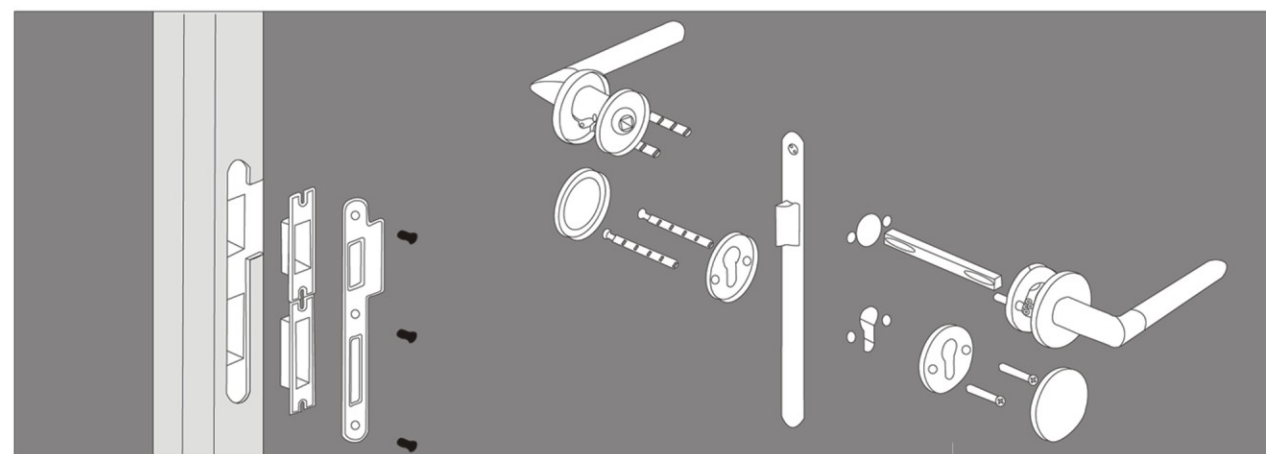

功能描述
function detail

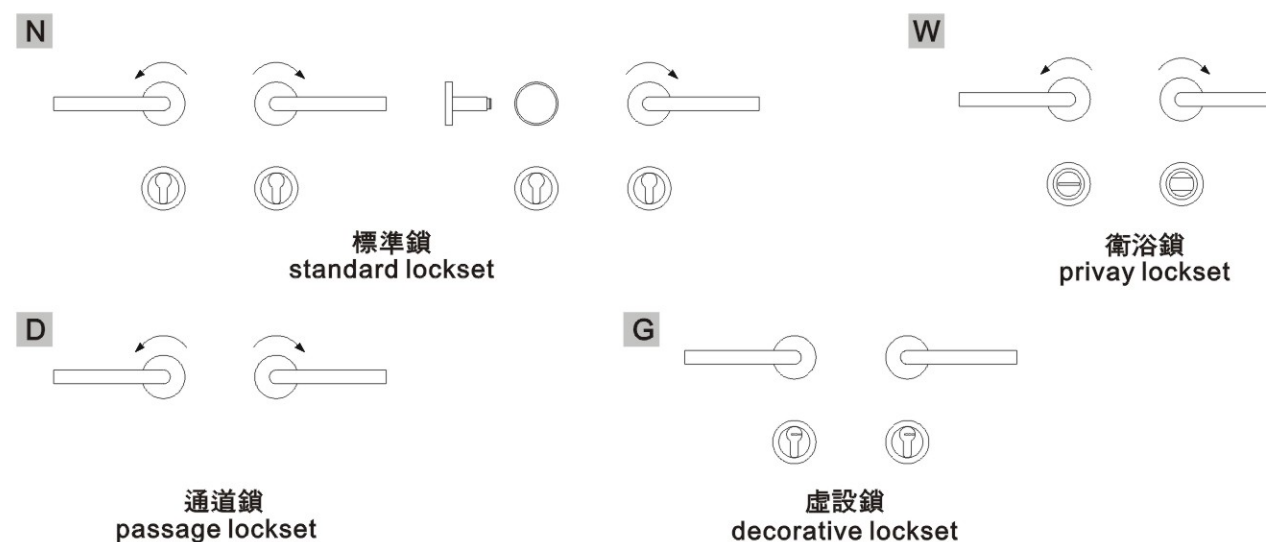



Concise

Noble Character can not be Covered

EA-P-60 (tube)

Handle: 2 pcs
Rose: 2pcs inner / outer
Escutheons: 2pcs inner / outer
Sprindle: 1pcs

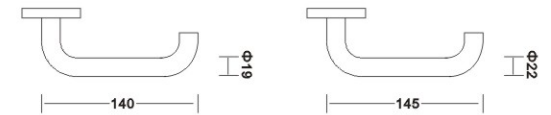

FINISH: Polished stainless steel (PSS)
Satin stainless steel (SSS)
Titanium Plated
DOOR THICKNESS: 35mm to 45mm

EA-6001 (tube) sss



EA-6003 (tube) sss



EA-6045 (tube) sss



EA-6046 (tube) sss



EA-6053 (tube) sss



EA-6047 (tube) sss



EA-6048 (tube) pss+sss



EA-6038 (tube) sss



EA-6042 (tube) sss



EA-6002 (tube) pss+sss

鎖體配置
corresponding mortise fixing
參照P31~P32
refer to page 31 to page 32

表面處理
finishing detail
參照P29
refer to page 29

NEW NEW DESIGN

TOP SALED

● SOLID

○ TUBE

EA-P-63

(tube)

Handle: 2 pcs
Rose: 2pcs inner / outer
Escutheons: 2pcs inner / outer
Sprindle: 1pcs

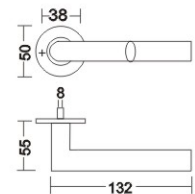

FINISH: Polished stainless steel (PSS)
Satin stainless steel (SSS)
Titanium Plated
DOOR THICKNESS: 35mm to 45mm

EA-P-63

(solid)

Handle: 2 pcs
Rose: 2pcs inner / outer
Escutheons: 2pcs inner / outer
Sprindle: 1pcs

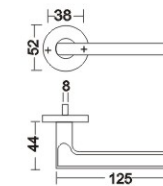

FINISH: Polished stainless steel (PSS)
Satin stainless steel (SSS)
Titanium Plated
DOOR THICKNESS: 35mm to 45mm

EA-6331 (tube) sss



EA-6330 (solid) sss

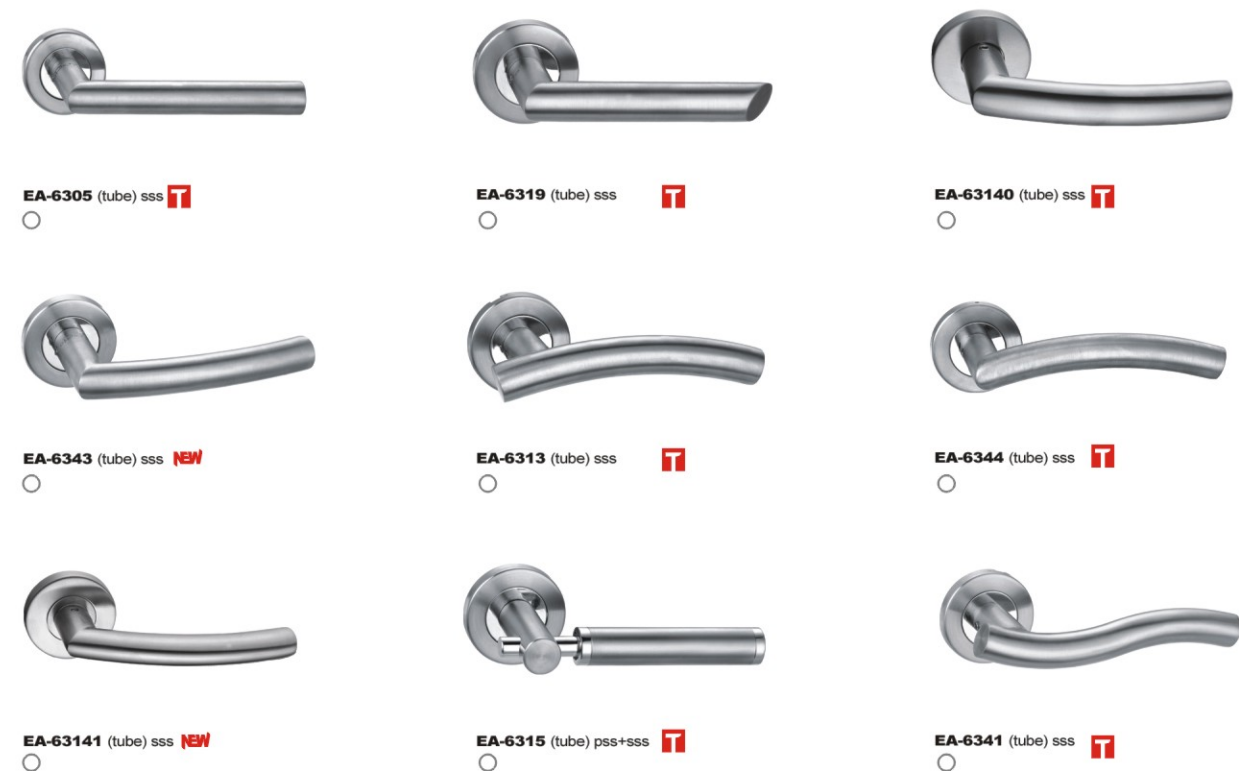

鎖體配置
corresponding mortise fixing
參照P31~P32
refer to page 31 to page 32

表面處理
finishing detail
參照P29
refer to page 29

NEW NEW DESIGN
 TOP SALED
● SOLID
○ TUBE

鎖體配置
corresponding mortise fixing
參照P31~P32
refer to page 31 to page 32

表面處理
finishing detail
參照P29
refer to page 29

NEW NEW DESIGN
 TOP SALED
● SOLID
○ TUBE

EA-P-63

(tube+solid)

Handle: 2 pcs
 Rose: 2pcs inner / outer
 Escutheons: 2pcs inner / outer
 Sprindle: 1pcs

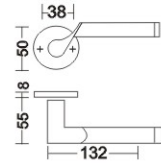

FINISH: Polished stainless steel (PSS)
 Satin stainless steel (SSS)
 Titanium Plated
 DOOR THICKNESS: 35mm to 45mm

EA-63112 (tube+solid) pss+sss



EA-6372 (tube+solid) pss+sss



EA-6373 (tube) pss+sss



EA-6352 (tube) pss+sss



EA-6352 (tube) pss+sss



EA-6380 (tube) pss+sss



EA-6374 (tube) pss+sss

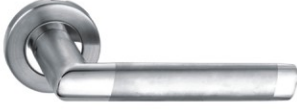

EA-6331b (tube) pss+sss



EA-6396 (tube) pss+sss **NEW**



EA-63113 (tube) pss+sss **NEW**



鎖體配置
 corresponding mortise fixing
 參照P31~P32
 refer to page 31 to page 32

表面處理
 finishing detail
 參照P29
 refer to page 29

NEW NEW DESIGN

TOP SALED

● SOLID

○ TUBE



STRIKING AND EFFUSME
 ROMANCE MAKE
 EVERYONE
 REFRESHING



EA-P-70

(solid)

Handle: 2 pcs of casting Lever handle
 Rose: 2pcs of casting Rose
 Escutheons: 2pcs of casting escutheons
 Sprindle: 1pcs

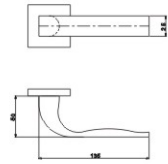

FINISH: Polished stainless steel (PSS)
 Satin stainless steel (SSS)
 Titanium Plated
 DOOR THICKNESS: 35mm to 45mm

EA-P-73

(tube)

Handle: 2 pcs
 Rose: 2pcs inner / outer
 Escutheons: 2pcs inner / outer
 Sprindle: 1pcs

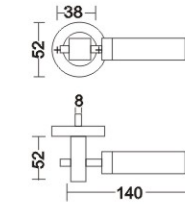

FINISH: Polished stainless steel (PSS)
 Satin stainless steel (SSS)
 Titanium Plated
 DOOR THICKNESS: 35mm to 45mm

EA-70138 (sold) sss **NEW**



EA-7377 (tube) pss+sss



EA-70139 (solid) sss **NEW**



EA-7063 (solid) **NEW**



EA-7061 (solid) sss **T**



EA-7062 (solid) sss **NEW**



EA-7077 (solid) sss



EA-7064 (solid) sss **T**



EA-7028 (tube) sss

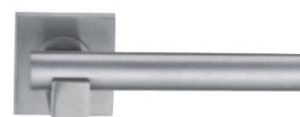

EA-73119 (tube) sss **NEW**

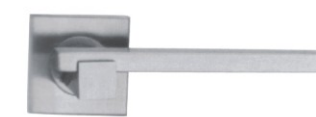

EA-73131 (tube) sss **NEW**



EA-7328 (tube) sss **T**



EA-73120 (tube) sss **NEW**



EA-73132 (tube) sss **NEW**



EA-73107 (solid) sss



EA-73133 (tube) sss **NEW**



EA-73134 (tube) sss **NEW**



EA-73110 (tube) sss **T**

鎖體配置
 corresponding mortise fixing
 參照P31~P32
 refer to page 31 to page 32

表面處理
 finishing detail
 參照P29
 refer to page 29

NEW NEW DESIGN

T TOP SALED

● SOLID

○ TUBE

鎖體配置
 corresponding mortise fixing
 參照P31~P32
 refer to page 31 to page 32

表面處理
 finishing detail
 參照P29
 refer to page 29

NEW NEW DESIGN

T TOP SALED

● SOLID

○ TUBE

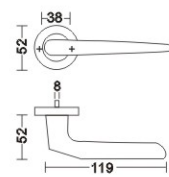

FINISH: Polished stainless steel (PSS)
Satin stainless steel (SSS)
Titanium Plated
DOOR THICKNESS: 35mm to 45mm

EA-P-68

(tube)

Handle: 2 pcs
Rose: 2pcs inner / outer
Escutheons: 2pcs inner / outer
Sprindle: 1pcs

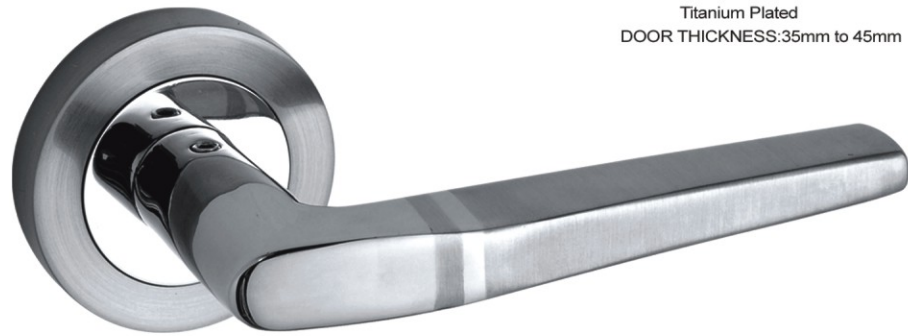

EA-68145 (tube) pss+sss **TI**



EA-68143 (tube) pss+sss **TI**



EA-68144 (tube) pss+sss **TI**



EA-6896 (tube) pss+sss **NEW**



EA-68113 (tube) pss+sss **NEW**

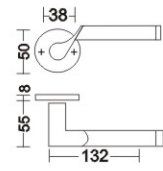

FINISH: Polished stainless steel (PSS)
Satin stainless steel (SSS)
Titanium Plated
DOOR THICKNESS: 35mm to 45mm

EA-P-69

(sold+tube)

interior door handle sets
Door and window handle



EA-69112 (sold+tube) pss+sss **NEW**



EA-6915 (solid) sss **NEW**



EA-6920 (tube) pss+sss **NEW**



EA-6909 (solid) pss+sss **NEW**



EA-6951 (solid) sss **NEW**



EA-6503 (tube) sss **TI**

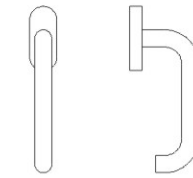

FINISH: Polished stainless steel (PSS)
Satin stainless steel (SSS)
Titanium Plated
DOOR THICKNESS: 35mm to 45mm

EA-P-65

(tube)

interior door handle sets
Door and window handle



EA-6505 (tube) sss **TI**



EA-6501 (tube) sss **TI**



EA-6506 (tube) sss **TI**



EA-6502 (tube) sss **TI**

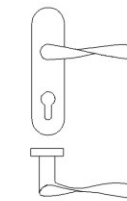

FINISH: Polished stainless steel (PSS)
Satin stainless steel (SSS)
Titanium Plated
DOOR THICKNESS: 35mm to 45mm

EA-P-66

(solid)

Handle: 2 pcs
2 pcs plate
Size: 235x40



EA-66104 (solid) sss



EA-6229 (solid) sss



EA-6602 (tube) sss



EA-6631b (tube) pss+sss



EA-6644 (tube) sss



EA-P-62

(tube)

Handle: 2 pcs
2 pcs plates
Size: 165x42
Aluminum inner base



FINISH: Polished stainless steel (PSS)
Satin stainless steel (SSS)
Titanium Plated
DOOR THICKNESS: 35mm to 45mm



EA-62103 (solid) sss



EA-6229 (solid) sss



EA-6201 (tube) sss



EA-6210 (tube) sss



EA-6237 (tube) pss+sss

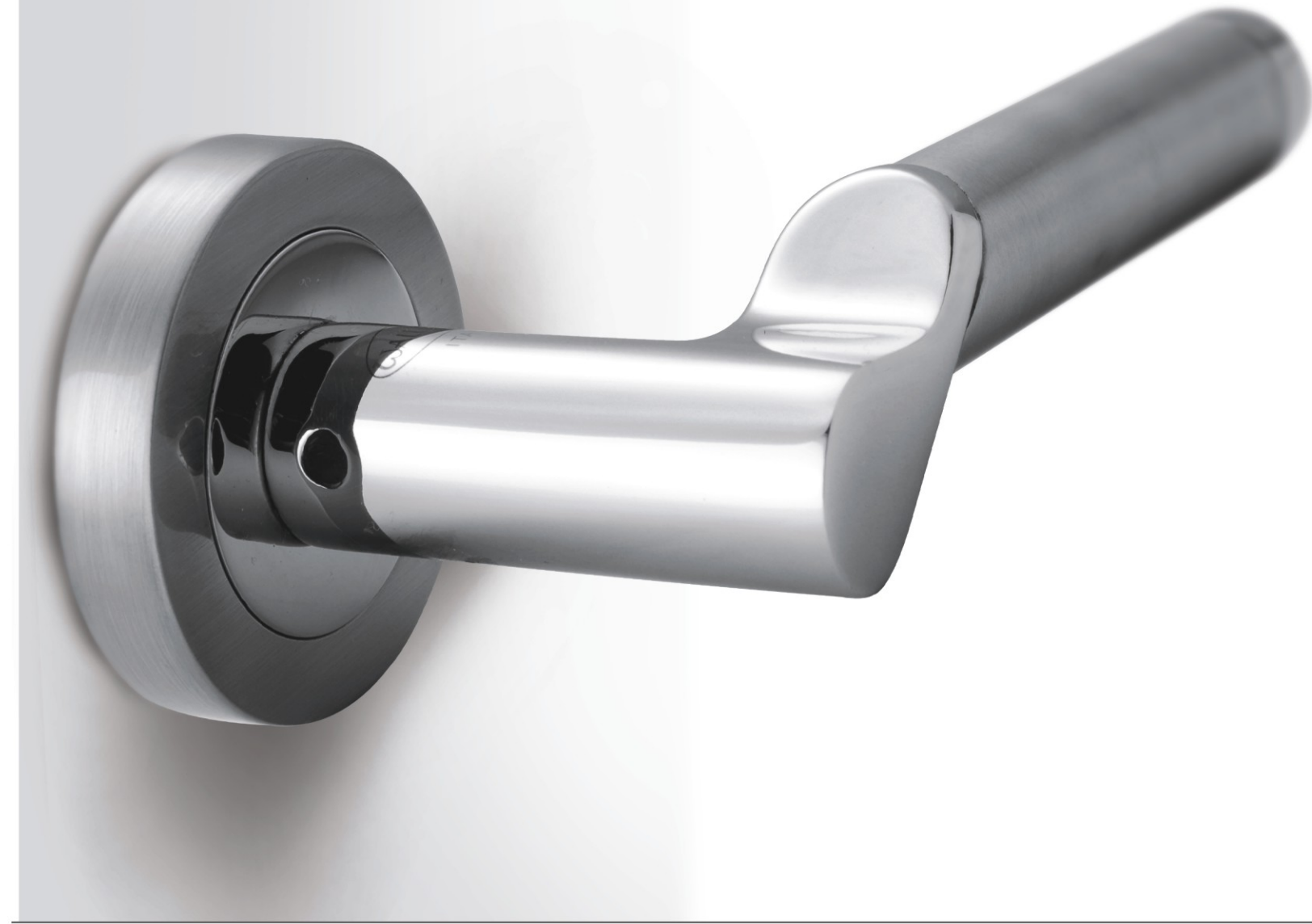

EA-P-61

(tube)

Handle: 2 pcs
2 pcs plates
Size: 165x42
Aluminum inner base

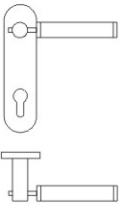

FINISH: Polished stainless steel (PSS)
Satin stainless steel (SSS)
Titanium Plated
DOOR THICKNESS: 35mm to 45mm



EA-6115 (tube) pss+sss



EA-6151 (tube+solid) pss+sss



EA-61110 (tube) sss



EA-6194 (tube) sss



EA-61112 (tube+solid) pss+sss



WINNING CLIENTS BY SINCERITY AND QUALITY
LEADING MANUFACTURER OF HARDWARE

EA-P-63

Wood Material

Handle: 2 pcs Anti-bacterial
wood type lever handle
Rose: 2 pcs inner / outer
Escutheons: 2 pcs inner / outer

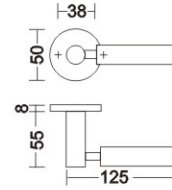

FINISH: Polished stainless steel (PSS)
Satin stainless steel (SSS)
Titanium Plated
DOOR THICKNESS: 35mm to 45mm

EA-6308 (tube) sss+wood



EA-6316 (tube) sss+wood



EA-6321 (tube) sss+wood



EA-6322 (tube) sss+wood



EA-P-63

Wood Material

Handle: 2 pcs Anti-bacterial wood type lever handle
Rose: 2 pcs inner / outer
Escutheons: 2 pcs inner outer

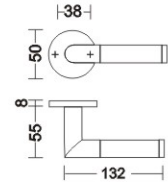

FINISH: Polished stainless steel (PSS)
Satin stainless steel (SSS)
Titanium Plated
DOOR THICKNESS: 35mm to 45mm

EA-6326 (tube) pss+sss



EA-6327 (tube) pss+sss



EA-P-64

EA-6403 (tube)

FINISH: Polished stainless steel (PSS)
Satin stainless steel (SSS)
Titanium Plated
DOOR THICKNESS: 35mm to 45mm

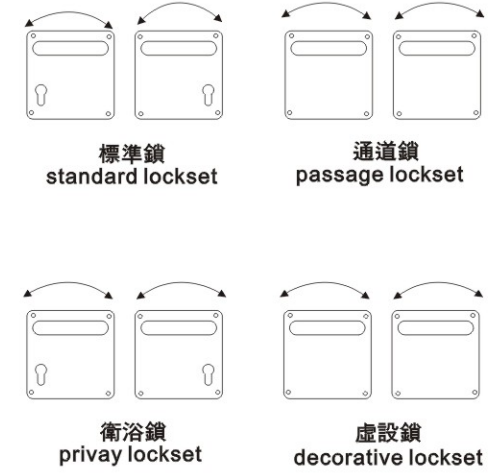

EA-P-67

EA-6703 (tube)

FINISH: Polished stainless steel (PSS)
Satin stainless steel (SSS)
Titanium Plated
DOOR THICKNESS: 35mm to 45mm



功能描述
Function Detail

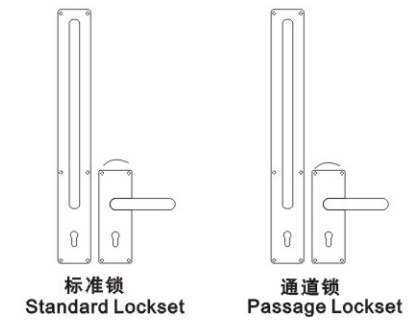

表面處理
Finishing Detail
01拉絲Satin 02分色Dual Finish

LEVER HANDLE
HANDLE

FINISH: Polished stainless steel (PSS)
Satin stainless steel (SSS)
Titanium Plated
DOOR THICKNESS: 35mm to 45mm



EA-90100 (solid) sss
FINISH: Polished stainless steel (PSS)
Satin stainless steel (SSS)
Titanium Plated
DOOR THICKNESS: 35mm to 45mm



EA-9020 (tube) PSS+SSS
FINISH: Polished stainless steel (PSS)
Satin stainless steel (SSS)
Titanium Plated
DOOR THICKNESS: 35mm to 45mm

Lever Handle Handle



EA-9072 (tube) PSS+SSS
FINISH: Polished stainless steel (PSS)
Satin stainless steel (SSS)
Titanium Plated
DOOR THICKNESS: 35mm to 45mm



EA-9056 (tube) sss
FINISH: Polished stainless steel (PSS)
Satin stainless steel (SSS)
Titanium Plated
DOOR THICKNESS: 35mm to 45mm



EA-9068 (solid) PSS+SSS
FINISH: Polished stainless steel (PSS)
Satin stainless steel (SSS)
Titanium Plated
DOOR THICKNESS: 35mm to 45mm

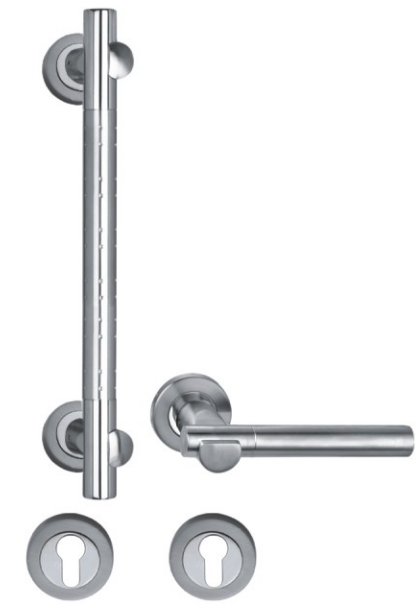

EA-9052 (tube) sss
FINISH: Polished stainless steel (PSS)
Satin stainless steel (SSS)
Titanium Plated
DOOR THICKNESS: 35mm to 45mm



EA-90112 (tube) sss

FINISH: Polished stainless steel (PSS)
Satin stainless steel (SSS)
Titanium Plated
DOOR THICKNESS: 35mm to 45mm



EA-9036 (tube) sss

FINISH: Polished stainless steel (PSS)
Satin stainless steel (SSS)
Titanium Plated
DOOR THICKNESS: 35mm to 45mm



EA-9077 (tube) PSS+SSS

FINISH: Polished stainless steel (PSS)
Satin stainless steel (SSS)
Titanium Plated
DOOR THICKNESS: 35mm to 45mm



EA-9062 (solid) sss

FINISH: Polished stainless steel (PSS)
Satin stainless steel (SSS)
Titanium Plated
DOOR THICKNESS: 35mm to 45mm



EA-9061 (solid) sss

FINISH: Polished stainless steel (PSS)
Satin stainless steel (SSS)
Titanium Plated
DOOR THICKNESS: 35mm to 45mm



EA-9058 (tube) sss

FINISH: Polished stainless steel (PSS)
Satin stainless steel (SSS)
Titanium Plated
DOOR THICKNESS: 35mm to 45mm



EA-9015 (tube) PSS+SSS

FINISH: Polished stainless steel (PSS)
Satin stainless steel (SSS)
Titanium Plated
DOOR THICKNESS: 35mm to 45mm



EA-9057 (tube) sss

FINISH: Polished stainless steel (PSS)
Satin stainless steel (SSS)
Titanium Plated
DOOR THICKNESS: 35mm to 45mm

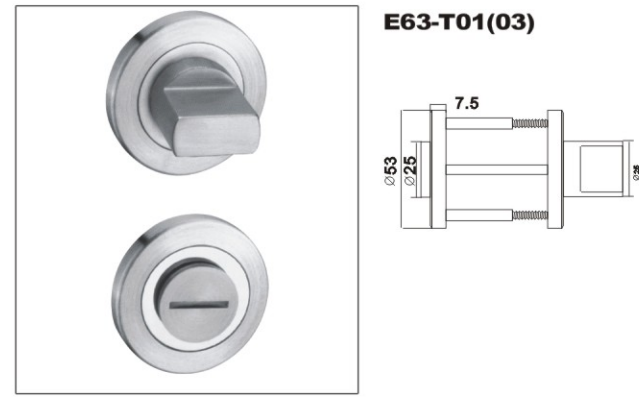

E63-T01(03)

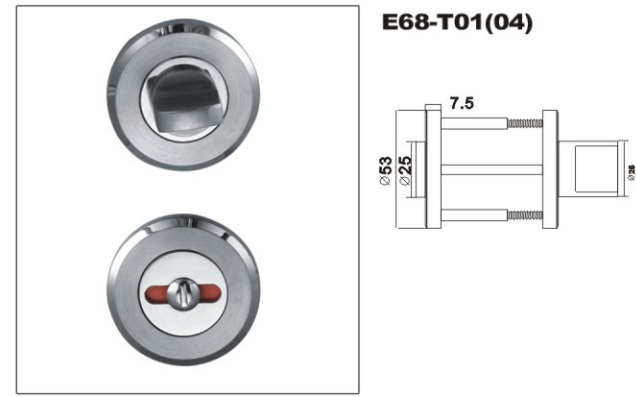

E68-T01(04)

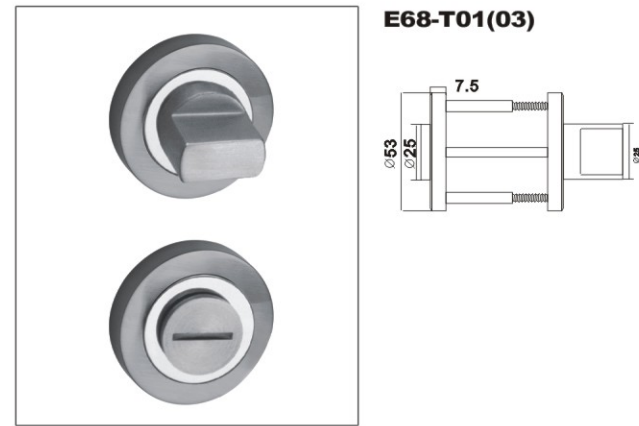

E68-T01(03)

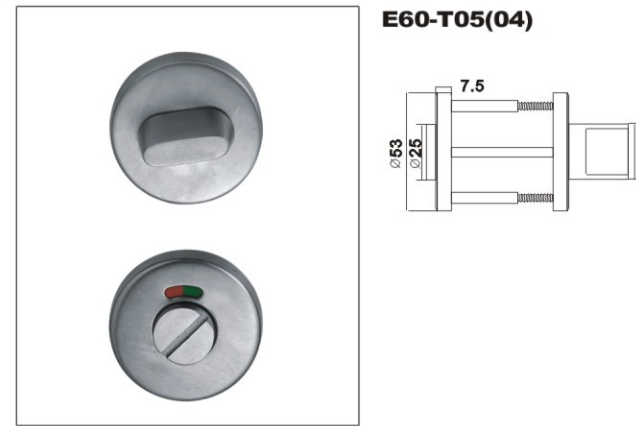

E60-T05(04)

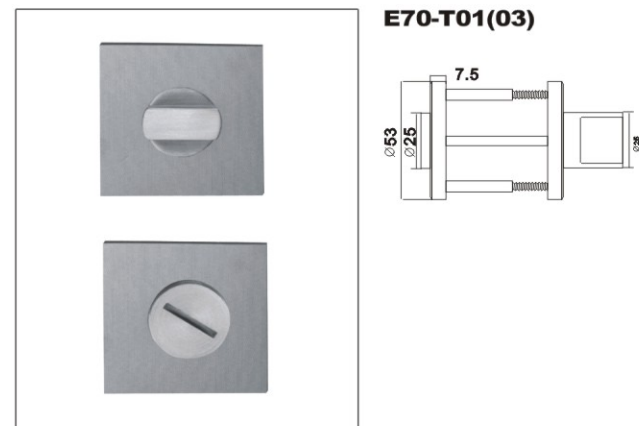

E70-T01(03)

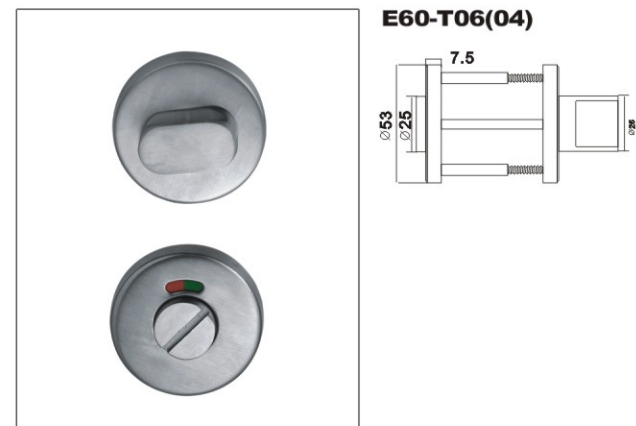

E60-T06(04)



E60-T10(03)



Art:03
BK4585 (三杆雙舌鎖)
Sash lock



Art:05
BK4585 (單杆雙舌鎖)
Privacy lock



Art:04
BK5572 (單杆雙舌鎖)
Sash lock



Art:09
BK3585 (單杆雙舌鎖)
Sash lock

Mortise Lock



Art:06
BK45A (三杆通道鎖)
Passage lock



Art:01
BK45B (斜舌通道鎖)
Passage lock



Art:010
BK3585 (滾珠圓舌鎖)
Mortise lock with roller ball latch



Art:07
BK4585 (滾珠圓舌鎖)
Mortise lock with roller ball latch



Art:12
BK35A (單杆通道鎖)
Passage lock



Art:11
BK45D (移門勾鎖)



Art:08
BK55B (美式房門鎖)



Spindle: 1#



Spindle: 2#



Spindle: 3#

Rose (内盖)

Material:stainless steel or metal



R-01



R-02



R-03

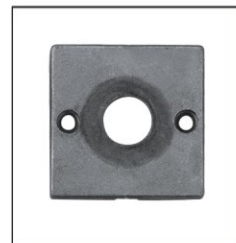

R-73



R-04



R-05



R-06

Rose (内盖)

Material:aluminum

Escutcheon

Material:stainless steel



E-01



E-02



E-03



E-04



E-05



E-06



E-73

Escutcheon

Material:stainless steel



R-01b



R-02b



R-03b

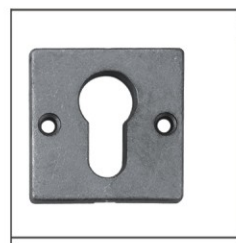

R-73b



R-04b



R-05b



R-06b



LEVER HANDLE
SERIES SYTEM
STYEL

LEVER HANDLE

SERIES SYTEM

参考拉手型号每款拉手
均可互配不同的盖

NEW NEW DESIGN

TOP SALED

● SOLID

○ TUBE

FINISH: Polished stainless steel (PSS)
Satin stainless steel (SSS)
Titanium Plated

DOOR THICKNESS: 35mm to 45mm



EA-6001 (tube) pss+sss **TOP SALED**
○



EA-6002 (tube) PSS+SSS **TOP SALED**
○



EA-6003 (tube) sss **TOP SALED**
○



EA-6304 (tube) sss
○



EA-6305 (tube) sss **TOP SALED**
○



EA-6306 (tube) sss
○



EA-6307 (tube) sss
○



EA-6308 (tube) sss **TOP SALED**
○



EA-6309 (tube) PSS+SSS
○



EA-6310 (tube) sss **TOP SALED**
○



EA-6311 (tube) sss **TOP SALED**
○



EA-6312 (tube) sss
○



EA-6313 (tube) sss **TOP SALED**
○



EA-6014 (tube) sss
○



EA-6315 (tube) sss
○



EA-6316 (tube) sss
○



EA-6317 (tube) sss
○



EA-6318 (tube) sss
○



EA-6319 (tube) sss **TOP SALED**
○



EA-6320 (tube) pss+sss
○



EA-6321 (tube) sss
○



EA-6022 (tube) sss
○



EA-6023 (tube) sss **TOP SALED**
● ○



EA-6024 (tube) sss
○



EA-6325 (tube) sss
○



EA-6326 (tube) sss **TOP SALED**
○



EA-6327 (tube) sss **TOP SALED**
○



EA-6328 (tube) sss **TOP SALED**
○



EA-6329 (solid) sss
●



EA-6330 (solid) sss **TOP SALED**
●



EA-6331 (tube) pss+sss **TOP SALED**
○



EA-6331B (tube) sss **TOP SALED**
○



EA-6332 (solid) sss
●

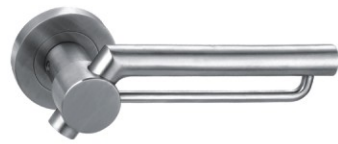

EA-6333 (tube) sss
○

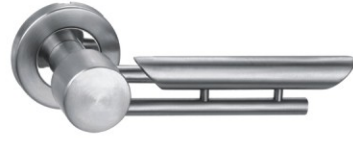

EA-6334 (tube) sss
○



EA-6335 (solid) sss 
●



EA-6351 (tube) pss+sss 
● ○



EA-6352 (tube) pss+sss 
○

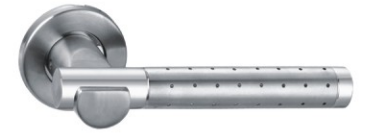

EA-6352A (tube) pss+sss 
○



EA-6336 (tube) pss+sss
○



EA-6337 (tube) pss+sss 
○



EA-6038 (tube) sss
○



EA-6053 (tube) sss
○



EA-6354 (tube) sss
● ○



EA-6055 (tube) sss
○



EA-6339 (tube) sss
○



EA-6340 (tube) sss
○



EA-6341 (tube) PSS+SSS 
○



EA-6356 (tube) sss 
○



EA-6357 (tube) sss
○



EA-6358 (tube) sss
○



EA-6042 (tube) sss
○



EA-6343 (tube) sss 
○



EA-6344 (tube) sss 
○



EA-6359 (tube) sss
○



EA-6360 (tube) sss
○



EA-7061 (solid) sss 
● ○



EA-6045 (tube) sss 
○



EA-6046 (tube) sss 
○



EA-6047 (tube) sss 
○

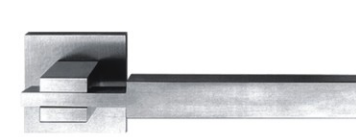

EA-7062 (solid) sss
● ○



EA-7063 (solid) sss
●



EA-7064 (solid) PSS+SSS 
● ○



EA-6348 (tube) PSS+SSS 
○

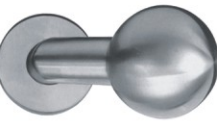

EA-6349 (tube) sss
○



EA-6350 (tube) sss
○



EA-6365 (solid) sss
●



EA-6366 (solid) sss
●



EA-6367 (solid) sss 
●



EA-6368 (solid) pss+sss 
● ○



EA-6369 (tube) pss
○



EA-6370 (solid) sss 
●



EA-7386 (solid) sss 
●



EA-6387 (solid) sss
●



EA-6388 (solid) sss 
●



EA-6371 (solid) pss
●



EA-6372 (tube) sss 
○



EA-6373 (tube) pss+sss 
○



EA-6389 (solid) sss
●



EA-6390 (solid) sss
●



EA-6391 (solid) sss
●



EA-6374 (tube) sss
○



EA-6375 (tube) sss
○



EA-6376 (tube) pss+sss
○ ●



EA-6392 (solid) sss
●



EA-6393 (solid) sss 
●



EA-7394 (tube) sss
○



EA-7377 (tube) pss+sss
● ○



EA-6378 (tube) sss
○



EA-6379 (solid) pss
●



EA-6395 (solid) sss 
●



EA-6396 (solid) sss 
○



EA-6397 (solid) sss
○



EA-6380 (tube) sss
○



EA-6381 (tube) sss 
●



EA-6382 (solid) PSS+SSS 
●



EA-6398 (solid) sss 
●



EA-7399 (solid) pss
●



EA-63100 (solid) sss 
● ○



EA-6383 (solid) sss
●



EA-6384 (solid) sss 
●



EA-6385 (solid) PSS+SSS
●



EA-63101 (solid) sss
●



EA-63102 (solid) sss
●



EA-63103 (solid) pss+sss 
● ○



EA-63104 (solid) sss



EA-63105 (solid) sss



EA-63106 (solid) sss



EA-63122 (solid) sss



EA-6123 (solid) sss



EA-6124 (solid) sss



EA-73107 (solid) sss



EA-63108 (solid) sss



EA-63109 (solid) pss+sss



EA-6125 (solid) sss



EA-63126 (solid) sss



EA-63127 (solid) sss



EA-63110 (solid) sss



EA-63111 (solid) pss



EA-63112 (tube) sss



EA-63128 (solid) sss



EA-63129 (solid) sss **NEW**



EA-63130 (solid) sss



EA-63113 (tube) pss



EA-63114 (solid) pss **NEW**



EA-66115 (solid) pss



EA-73131 (tube) sss **NEW**



EA-73132 (tube) sss **NEW**



EA-73133 (tube) sss **NEW**



EA-63116 (solid) pvd



EA-63117 (solid) pss



EA-63118 (solid) sss

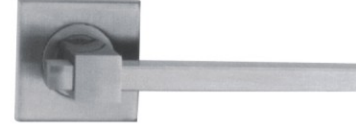

EA-73134 (tube) sss **NEW**



EA-63135 (solid) sss



EA-63136 (solid) sss

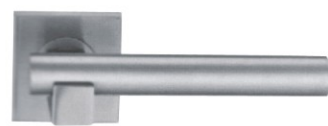

EA-73119 (tube) pss **NEW**



EA-73118 (tube) pss **NEW**



EA-63121 (solid) sss



EA-63137 (solid) sss



EA-70138 (solid) sss **NEW**



EA-70139 (solid) sss **NEW**



EA-60140 (solid) sss NEW



EA-63141 (solid) sss NEW



EA-63142 (solid) sss



EA-68143 (tube) pss+sss NEW



EA-68144 (tube) pss+sss NEW



EA-68145 (tube) pss+sss NEW



NOBLE CHARACTER
CAN NOT
BE COVERED



WELCOME

MALIGAYANG PAGDATING welkom

welkom 환영합니다

Selamat datang ยินดีต้อนรับ

ترحيب

ຍິນດີຕ້ອນຮັບ

নর্ষ

환영합니다

W

IE

بى حرت

歡迎

желанный

Bienvenue willkommen

желанный WELCOME Καλώς ήρθες

欢迎 ようこそ

benvenuto willkommen ترحيب



To Our Valued Customers

We would like to say " Thank You " to all of our customers and employees . Your help and encouragement has made it possible for E-PAI Metal Products Company to grow into the industry leader , and we plan to continue growing . Our goal is to listen , and challenge ourselves to better serve our customers.

Because of you we set our standards for innovation , service , and selection of quality products at the highest level . We consider it our responsibility to bring new technology to our industry so that we can all prosper.

We believe the Internet is the tool of the future , and E-PAI Metal Products Company is making a major commitment to the development of our web site to be your source for information and technical support . Access to all E-PAI products and services is available to you at epai-hardware.com , the most comprehensive and convenient informati source we can offer our customers

The E-PAI web site is a powerful communications device between business and the E-PAI people who serve you . It also allows us to empower you to have more flexibility and control of your orders , making it possible for you to contribute in the process of our providing you with excellent service . We invite you to visit us at epai-hardware.com . We are ready to provide you with 7*24 online service.

This the catalog is the latest evidence of our commitment to bring you the finest and most comprehensive line of glass and architectural hardware . We are proud to make it available to you

E-PAI's success has been made possible through our transition into manufacturing . We are producing a growing number of products to fill all of your requirements , and we Will continue to listen to your ideas for products to manufacture for our industry . As always , we plan to expand our product line to be a continuing source for the glass industry . We are also adding to the number of distribution facilities we use to serve you , with plans for more to come overseas

Again , we thank you for your continued support . Without your ideas for better service , new products , and generally high expectations , we would not have enjoyed our growth and success . Let's continue our success together.



NEWHUABAO (Hardware) Industrial Co., Ltd.

E-PAI Metal products Co.Ltd.

EPAINOX Technology (GD) Manufactures Co., Ltd.



E-PAI Manufacturing

- Making Quality Products for Almost 23 years
- Use Advanced Pdca Manufacturing Process
- Machinery And Technical Expertise Are Fully Utilized In Production.
- Strictly control quality management, we produce stainless steel pipes by ourselves

E-Pai's Precision Design And Engineering Is The Key To Quality



E-PAI is ISO9001-2015 Certified

It all starts with ISO9001-2015 certification . We produce over 3,000 items for the industries we serve in our ISO9001 Certified manufacturing facilities . Our adherence to the strictest of standards reflects the commitment of our employees to provide the highest quality products.

Engineers Provide Support For Product Development, Testing And Production

E-PAI's engineering department reviews the design and work plan with customers to solve product feasibility, safety issues, and other solutions, so as to provide us with accurate quotations and more accurate technical support.

Innovation Makes Us a Leader

E-PAI has been manufacturing and providing new and innovative products for nearly 28 years, and we know we can't just wait and die because if we do, others will surpass us. And this is not the whole reason to become a leader. Many E-PAI products incorporate features that others don't, because we feel that no product is so good that it cannot be improved.



E-Pai Quickly Customize The Project And Shorten The Delivery Cycle

The goal of the E-PAI quick customization program is to achieve the shortest delivery time from sketch to quotation to manufacturing to delivery of all products produced by E-PAI. This can be achieved in a variety of ways, one of the important factors is to let the whole process proceed "internally." Allows electronic manufacturing control processes, such as mold research, raw material procurement, cutting optimization, high-speed manufacturing, surface treatment, powder coating, batch coating, packaging, and transportation, so that products can be delivered to you more quickly and efficiently.

Experienced, Knowledgeable Team Dedicated From Start to Finish

Our staff has decades of experience in the various stages of manufacturing. Our people draw upon their resources to find innovation and efficiency in our manufacturing processes , allowing us to build top quality products at prices that are always competitive. From the procurement of raw materials to final shipment of finished goods , it's our experience that makes the difference.

Do you have a new product that could be made by E-PAI ? Need help with a current products ? Contact us

We welcome the opportunity to serve you, and are committed to providing your business with the services that produce quality products. To discuss the possibility of working with E-PAI manufacturing we invite you to contact E-PAI technical sales at +86(757)85751892 in the China. To send e-mail go to manager@epai-hardware.com, click on contact us.

E-PAI Manufacturing's Strengths Become Your Strengths

E-PAI's Manufacturing Quality

E-PAI Manufacturing has decades of product manufacturing experience in the industries we serve. We have profited from how to manufacture high-quality products, and in a cost-effective way. We also learned how to satisfy customers with high standards.

Automatic Stainless Steel Pipe Production Line By Our selves



E-pai has a full-automatic stainless steel pipe production line, and the product conforms to iso 9001-2015 quality embodiment control.

There are 28 production lines with the specifications of round pipe and square pipe covering 9.5mm-326mm and the thickness of 0.4mm-8mm.

The surface treatment is generally superior to the market average level of 800# mirror surface and 320# hair line, which effectively enhances the anti rust and anti rust ability of stainless steel pipes.

The production materials 201, 304, 316 and 316L are all raw materials of high-quality and well-known brands. The materials have their own products through years of production tests, and effectively control their machining performance and ductility.

Let E-PAI Manufacturing Put Our Expertise and Resources to work for You

E-PAI Can Meet Your Manufacturing Needs With Our Extensive Array of Equipment and Our Knowledgeable Staff.

E-PAI can meet the manufacturing needs of businesses large and small . E-PAI Manufacturing offers a variety of services to help you produce high quality products you will be proud to put your name on. We manufacture quality tools , parts , and accessories for some of the world's largest corporations , while also serving the needs of smaller ,more specialized businesses . E-PAI Will help you make products you can provide to your customers with complete confidence.

What E-PAI Offers as Your Manufacturing Partner

E-PAI's capabilities encompass almost every phase of the manufacturing process, from the early stages of design, all the way through to packaging and shipment. We can supply such services as:

- Design
- Machining
- Polishing
- Cleaning
- Bending
- Finishing
- Packaging
- Engineering
- Powder
- Shipping
- Cutting
- Welding
- Milling
- Assembly
- Coating

Let E-PAI Manufacturing Work for You



Stainless steel precision wax casting

Mature stainless steel precision wax casting, rich production experience, can meet your new development mold, product design, production casting, mechanical production, surface polishing, electroplating needs in all aspects.



CNC plate bending machine

E-pai has advanced bending equipment for steel plate, which can produce bending plate with thickness of 0.4mm ~ 16mm

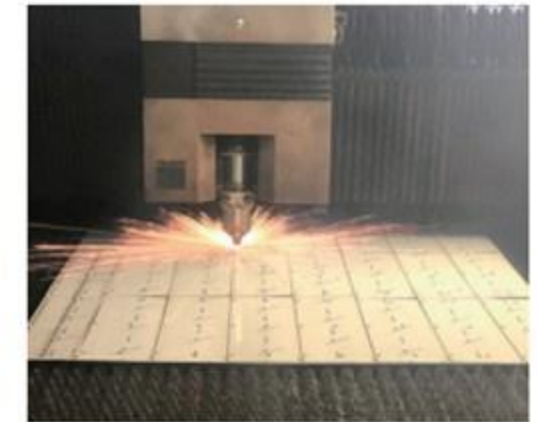

15000w CNC laser cutting SLCF-G2580V/F

With advanced high-power 15000w laser cutting equipment, we can provide high-quality and solid support for your various artistic designs and high-quality sheet metal processing.

E-PAI's Machine Shop

Various hardware processing equipment to support different products.

- Complete Machine Shop Capabilities
- Mills , Lathes , Drills . Saws . Etc
- Cutting , Grinding , Drilling , Tapping , and More



E-PAI MANUFACTURING

Use E-PAI's Equipment and Processes to Develop Your Project



E-PAI's Metal Shear and Punch Department

- Metal Shearing of Up to 3 / 16 (4.7 mm) Thick Mild Steel
- Maximum Shearing Width of Up to 14 (4.2 m)
- E-PAI Manufacturing has 10 Punch Presses with Hundreds of Dies
- Custom Dies Made Quickly for Special Applications

E-PAI's Welding Center

- Over One Dozen Fully Equipped Welding Stations
- Welding Capabilities Include Aluminum , Brass , Stainless Steel , and More



E-PAI's Bending Department

- E-PAI has Over a Dozen Rotary Hydraulic Benders
- E-PAI has Hundreds of Dies for a Variety of Profiles and Radii
- E-PAI Offers a 3-Roller Bender to Bend Flat Bar , Square , Rectangular , or Round Tubing

E-PAI's Drilling Center

- Custom Multi-Head Drill Allows for One-Day Lead Time on Multiple Drilling Projects

E-PAI MANUFACTURING

E-PAI's Total Manufacturing Service Includes Customing Glass, Finishing, and Cleaning



E-PAI's Customing Temper Glass

- E-PAI's Urethane Bonding Provides Attachment Without Mechanical Fasteners for a Cleaner , More Modern Appearance
- American Ultraviolet Co . , Ultraviolet Bonding for Bonding Glass to Metal Without Mechanical Fasteners

E-PAI's Assembly Center

- Once Your Parts are Manufactured E-PAI's Assembly Center Can Put Them Together



E-PAI's Finishing and Polishing Department

- We Offer Finishing Capabilities for Aluminum , Brass , Stainless Steel , and More
- We Can Apply Brushed , Satin , and Hairline Finishes
- We Offer Polishing Capabilities for Aluminum , Brass , Stainless Steel , and More
- Almost Any Size or Length
- Climate Controlled Environment

E-PAI'S Cleaning Department

- Custom Designed Ultra Sonic Cleaner
- Capacity to Clean Parts After Finishing or Prior to Painting

Choose E-PAI as Your Manufacturer from Start to Finish

E-PAI Painting Center Now Includes SPraylat NEWLARTM with E-PAI as an Approved Applicator

- 100% Fluoropolymer Architectural Powder Coating
- Performs to AAMA 2605 Without the Use of Primer
- Green Technology –No VOC's/Hazardous Waste
- Superior Scratch and Abrasion Resistance
- Exceptional Chemical Resistance
- 15-Year Performance Warranty
- Powder Coating Up to 20 foot (6 m) Lengths
- Ability to Paint Any Architectural Color on the Market

E-PAI's determination to meet the demands of today , 's challenges for superior performing architectural products and environmentally friendly application properties has been achieved through Spraylat's NEWLARTM which offers superior mechanical properties , has a harder finish , and resists scratching and marring during fabrication , assembly and installation . NEWLARM is warranted for 15 years when applied by approved applicator E-PAI Company

E-PAI Additional Services Include:

- A Staff of Engineering Professionals Willing to Work With You to Achieve Maximum Quality Products
- E-PAI's Worldwide Volume Purchasing Power on Materials
- Cutting Services for Production and Custom Order Jobs
- Batch Manufacturing for Reduced Turnaround Times and Costs per Unit
- Expert Packaging and Worldwide Shipping

Your Best Choice in a Manufacturing Partner

When looking for a manufacturer to make your idea or concept into a marketable product , you can choose E-PAI Manufacturing with confidence . We at E-PAI know that our years of experience , our modern technology , and our commitment to excellence can be your best choice for a partner In manufacturing



E-PAI Automated Painting Center



- Automated Powder Coat Line for Black Paint
- Washer , Dryer , Powder Application , and Oven for Lengths Up to 48 (1219 mm)

Why do you choose us?

- (1) We have more than 22 years experience specialized in Stair and Handrail area.
- (2) Our factory products are exported to more than 86 countries.
- (3) We have our own sales team and designer team, so we offer you professional serve.
- (4) Most of our balustrade accessories are solid or deceasing (fabricate) , Quality is very good.
- (5) we can supply full range and varity products of your home decoration, so one-stop source can save cost.
- (6) Small quantity trial order is welcome
- (7) Products can be customized according to client' s requirements.
- (8) Our product are easy to install, most of handrail can be DIY fixed by no experience worker.
- (9) High quality control and Promptly delivery

Are you a trader or manufacturer ?

Of course, we are a factory. We have 22 years of production experience. The factory is located in the stainless steel (hardware building materials) production base-Foshan City. We welcome you to come to the factory to guide your work at any time. We are the professional manufacturer, welcome to our factory and showroom before you place order.

What grades of stainless steel do you use ?

We use commercial grades AISI 304 for internal applications and AISI 316 for external applications. You can mix depending upon the environment of your installation. If you have insufficient budget and use it indoors and in a non-humid environment, you can choose 201 stainless steel.

What diameter is the handrail ?

The tubes have outside diameters of 38.1mm, 42.4mm, 48.3mm and 50.8mm.

How high should my balustrade be ?

We should consider two situation.

- 1) Flat railing standard height,1100mm,1200mm or 1300mm from the ground.
- 2) Staircase railing standard height,900mm or 950mm from each step.

How thickness is the handrail?

The wall thickness of the post is 2mm (diameter 42.4mm), 2.6mm (diameter 48.3mm) and 3mm (diameter 50.8mm). Handrail pipe thickness is 1.5mm.

I want the banister to go on my left hand wall is this possible ?

Yes, it can go on either wall depending which way round you put it. Just turn it around, lengthways.

I want to fit a new handrail. Where do I measure from ?

If it's a banister rail replacement, just measure your existing one. If it's a balustrade that you're after, please send us your design in the form of a dimensional sketch or drawing.

Do you have a new product that could be made by E-PAI ? Need help with a current products ? Contact us

We welcome the opportunity to serve you, and are committed to providing your business with the services that produce quality products. To discuss the possibility of working with E-PAI manufacturing we invite you to contact E-PAI technical sales at +86(757)85751892 in the China. To send e-mail go to service@epai-hardware.com, click on contact us.

FAQ

How do you package the goods?

The balustrade and hardwares accessories are packaged separately by cartons, glass and wooden components are packaged by the wooden box Long stainless steel pipes are packaged by the fiber bags

What is the convenient way to pay?

- (1) In generally, Our usual terms of payment is One Touch, T/T, Western Union, Paypal.
- (2) If other way for payment is more convenient for you, we will try our best to support you

Can you provide us the goods according to our drawing?

All the railing and the staircase can be custom made in our factory, Please provide us your drawing, then we can make it according to your drawing.

What details should be offer in the first inquiry ?

The following details are very important in the first inquiry

- (1) Which material of stainless steel you want?
- (2) Which items of our products are you interested in?
- (3) How many quantity you want?
- (4) We are more pleased to receive product drawings or fabrication drawing, if you can' t , you can offer the photo of your project, our professional designer would inform you what we should need?

What is about the delivery time?

In general speaking, the delivery time is about 30 days.

How about the shipment ?

- (1) small quantity you can choose by air
- (2) less than one container you can choose LCL shipment by sea
- (3) one container or more than one container you can choose FCL shipment by sea.

E-PAI MANUFACTURING

1997-1998
START A BUSINESS



1997 - Established "New Hua Bao Hardware Decoration Materials" in Foshan, sold "NHB" luxury door handle and gated hardware products, the company successfully started from scratch and hold the foot in the market, the product initially recognized by the market.

1998 - The company opened "New Hua Bao Hardware Factory", plant area of 400 square meters, began production for sale "NHB" luxury door handle.

1999-2000
TRANSFORMATION



1999- the company formulated innovative product strategy, featured stainless steel glass door handle, and set off the trend of domestic door handle color processing. Expand production scale in the same year.

2000- the company imported the iso9001-2000 direct pull system, started production standardization process, and laid a good management foundation.

2003-2006
OPEN UP



2003- The Company adjusted its marketing strategy and started to expand its foreign markets.

2006 - Become one of the manufacturers with the largest number of stainless steel door handle export single products, and maintain the growth continuously Keep the largest single product manufacturers, a leading manufacturer.

2009-2010
Profession



2009- In order to better control the quality of stainless steel handle, control incoming quality and put into production stainless steel pipe production line. And customer recognition.

2010 - EPAI PIPECO, established!

2016-2017 At the same time of rapid development, the company has vigorously grasped the management and upgrading work. The entire line of management is introduced into the ISO9001-2008 management system and integrated into the advanced ERP management system. Enhance management and quality control as the company's top priority. Stair railings and glass bathroom hardware have also been developed. High quality and innovative product design have won stable orders from customers. The entire line of products are exported to more than 78 countries and regions around the world.

2016-2017
Strengthen management



2014 -2015 The branches have developed smoothly, and the quality of the door handle and stainless steel pipe is better than that of the peers, and has been developed at a high speed. Door handles exported 720000 to become the industry's first brand. The annual sales volume of stainless steel pipes exceeded 10,000 tons.

2014-2015
Smooth development



2013- Once again, the company expanded its production and moved into a new modern and modern factory building covering an area of 30,000 square meters. Invested in the new 26 precision automatic stainless steel production lines, the export value of the year exceeded 12 million US dollars.

2013
Expand production



2011- Increase investment, purchase 10 precision automatic stainless steel pipe production lines, monthly sales of 300 tons.

2012-, put into production "EPAI UNION" building hardware factory, producing all kinds of stainless steel bathroom clip, stainless steel staircase accessories.

2011-2012
Increase Investment



2018-2019 EPAI is fully committed to becoming a nationally renowned brand of stainless steel building materials, with the goal of production and sales and customer satisfaction as the first goal, practicing the spirit of mindfulness, altruism and virtue, and building the first brand platform of stainless steel building materials industry!

2018~2019
MISSION



Continue to innovate

Strengthen product innovation, improve the full chain layout of building materials, glass, and hardware through automated production, and optimize the industrial structure

2023-2024

Create a timeless stainless masterpiece

Become an excellent stainless steel building chain supply and service provider

Future

EPAI

MISSION & GOAL

Producing first-class products and cultivating top talents .
Creating a happy working environment to make all staff grow up and realize their own value & starting the capital market operation successfully .





—— 诚待天下客 · 质赢用户心 ——

NEW ERA, NEW MISSION, NEW JOURNEY

EPAI focuses on becoming a leading company in the field of stainless steel building materials, and develops healthily

Introduction

E-pai has been committed to the stainless steel architectural hardware industry for 31 years, started its business for 23 years, and entered into foreign trade for 17 years. Epai only does one thing- becoming one of the outstanding enterprises in the field of stainless steel building materials depth and becoming the pride of Chinese enterprises.

E-pai has been deeply developing stainless steel architectural hardware. Starting from stainless steel door handle, EPAI focuses on strict quality control, continuous innovation, perfect system management, strong technical support, mature supply chain, and professional service. Since 2009, and successfully replicated to high-end stainless steel tubes, stair railing systems and accessories, bathroom hardware products and systems. Now four series of products in many years of cultivation emerging, the world's 86 countries and regions customers praise and loyal cooperation support. Among them, there is no lack of some transnational famous brands, regional first, industry leading enterprises.

In "sincerity to maintaining truthful, quality win customers heart, accept eight party goods" business philosophy under the guidance, will, as always, adhere to the ISO9001-2015 management system, to do a good job of each item to meet customer demand, strongly expand to become excellent stainless steel building materials comprehensive results of each solution provider, committed and enterprise development.

To build an internationally renowned brand, to provide employees with opportunities for material and spiritual growth, and through our joint efforts, to promote the harmonious progress of the society and people. Create a "happy work, happy life" E-pai platform, toward the goal of building a centenary enterprise and strive hard!

Contact us: manager@epai-hardware.com

Our solutions are 7*24 (7 days & 24 hours) Always there for you!

EXTRAORDINARY,QUALITY,WITHIN REACH...



一派从事不锈钢建筑五金行业 31 年，创业 23 年，对外贸易 17 年。Epai 只做一件事——成为不锈钢建材领域的优秀企业之一，成为中国企业的骄傲。

一派公司一直致力于不锈钢建筑五金件的开发。以不锈钢门把手为起点，严把质量关，不断创新，完善的系统管理，强大的技术支持，成熟的供应链，专业的服务。自 2009 年以来，又成功复制到高端不锈钢管、楼梯扶手系统及配件、卫浴五金产品及系统。现四大系列产品在多年的培育中崭露头角，得到世界 86 个国家和地区客户的好评和忠诚的合作支持。其中不乏一些跨国知名品牌、区域第一、行业领先的企业。

在“诚信为本、质量赢客户心、收八方货”的经营理念指导下，将一如既往地坚持 ISO9001-2015 管理体系，做好每一项工作，满足客户需求，大力拓展成为优秀不锈钢建材综合成果的各解决方案提供商，致力于企业的发展。

打造国际知名品牌，为员工提供物质和精神成长的机会，通过我们的共同努力，促进社会和人民的和谐进步。打造“快乐工作，快乐生活”的 E-pai 平台，朝着建设百年企业的目标努力奋斗！

联系我们: manager@epai-hardware.com

我们的解决方案是 7*24 (7 天 24 小时) 随时为您服务!

新时代—新使命—新征程
一派公司聚焦成为不锈钢建材纵深领域领先的企业，健康发展

E-PAI MANUFACTURING



1 我们的使命

打造匠心正念团队、造匠心优质产品，装点大千世界，使企业、员工、客户持续发展、成长。

2 持续遵循正念、利他、厚德的创业精神理念。

3 我们的核心价值观

- * 灵活服务于每一个客户。
- * 廉洁。
- * 高效率。
- * 关心客户。
- * 学习。
- * 敬业
- * 奉献。
- * 追求自我实现和认知。
- * 开放性和自然性。
- * 信任。

4 五个工作原则评估我们的决策与忠诚:

- * 通过开放的充分的沟通，制定最严格的质量标准、服务。
- * 敬业，让客户感受到我们的热情。
- * 提供良好的工作气氛和彼此尊重。
- * 忠诚，对社会产生积极影响。
- * 我们的核心价值观是未来盈利及成功的必要条件。

5 我们对敬业精神的理解

- * 对知识的深切渴望，从本质开始，渗透到每一个细节。理解产品的质量与服务的重要性。
- * 对自己严格要求。
- * 深入了解客户。
- * 持续提高自己的专业知识。
- * 从不停下了自满，要不断学习增值。
- * 尽可能快速和有效的工作，节约客户的金钱和时间。

6 我们的愿景

打造永恒不朽杰作，让一派成为优秀的不锈钢全产业链供应商与服务商。

7 我们对良好的工作气氛的理解

- * 我们了解合作伙伴的需求。
- * 经常与客户保持沟通联系。
- * 深入了解客户的需求。
- * 创新服务方式。
- * 有效的沟通。
- * 优产品，优服务。
- * 持续改进感受的服务，永不满足于现状，让客户对我们的工作感到满意。
- * 我们必须不断努力超越客户的期望值。
- * 对待客户就像对自己一样。

8 我们对于开放的充分的沟通的理解

- * 我们总是为我们的客户着想。
- * 我们不接受与员工及客户之间的虚假关系。
- * 我们不欺骗客户，员工和自己。
- * 我们不做空的声明与承诺。
- * 开放地和适度地自然地表现我们正在做的事情。

9 我们对忠诚的理解

- * 诚实对待所有人（客户、合作伙伴、工作人员）
- * 我们羞于做羞耻的事情。
- * 关心客户的需求和利益。
- * 适当的优先顺序：客户、员工、自己。
- * 正当的收入来源。
- * 从不以次充好。
- * 多种形式的适当沟通。
- * 实现对员工的承诺，满足客户的需求。
- * 发现员工的优点。
- * 根据员工和客户的情况给予帮助。

E-PAI MANUFACTURING

1 Our mission

The ingenuity of the team, the creation of quality products, so that enterprises, employees, customers continue to develop and grow.



2 Continue to follow the entrepreneurial spirit of mindfulness, altruism, and virtue.

3 Our core values

- * Flexibility to serve every customer.
- * Integrity.
- * High efficiency.
- * Caring for customers.
- * Learning and dedication
- * Dedication
- * Pursue self-realization and cognition.
- * Openness and naturalness.
- * Trust

4 Five working principles assess our decision-making and loyalty:

- * Through the open and thorough communication, the most stringent quality standards and services are formulated.
- * Dedication, let customers feel our enthusiasm.
- * Provide a good working atmosphere and respect each other.
- * Loyalty has a positive impact on society.
- * Our core values are a necessary condition for future profitability and success.

5 Our understanding of open and adequate communication

- * We always think about our customers.
- * We do not accept false relationships with employees and customers.
- * We don't deceive ourselves, our customers, our employees.
- * We are not shorting statements and commitments.
- * Openness and moderation naturally represent what we are doing.

6 Our vision

- * Create a timeless stainless masterpiece and become an excellent supplier and service provider of stainless steel building materials.

7 Our understanding of professionalism

- * The deep desire for knowledge begins with the essence and permeates every detail. Understand the quality of the product and the importance of the service.
- * Strict requirements for yourself.
- * Gain insight into customers.
- * Continue to improve your expertise.
- * Never stop complacent, and constantly learn to add value.
- * Save money and time as much as possible by working as quickly and efficiently as possible.

8 Our understanding of a good working atmosphere

- * We understand the needs of our partners.
- * Always keep in touch with customers.
- * Gain insight into customer needs.
- * Innovative service methods.
- * Effective communication.
- * Excellent products, excellent service.
- * The service that continuously improves the feelings is never satisfied with the status quo and makes the customers satisfied with our work.
- * We must constantly strive to exceed customer expectations.
- * Treating customers is like being yourself.

9 Our understanding of loyalty

- * Treat everyone honestly (customers, partners, staff)
- * We are ashamed to do shameful things.
- * Care about the needs and interests of our customers.
- * Appropriate priorities: customers, employees, and yourself.
- * A legitimate source of income.
- * Never shoddy.
- * Various forms of proper communication.
- * Achieve commitment to employees and meet customer needs.
- * Discover their strengths.
- * Help according to the situation of employees and customers

E-PAI's HONOR



出口量的行业领导地位

INDUSTRY LEADERSHIP IN EXPORT VOLUME

Deeply cultivated in the industry for more than 31 years

在行业内深耕逾 31 多年

100%

100% Products are No.1 export in five continents and regional markets
Among them, five series of items are for sale NO.1
产品在五大洲、地区市场热销其中，五个系列单品为销售 NO.1

Exceed 超过

13,341,311 pair

Handle 拉手

More than 逾

76,827 ton

Stainless steel pipe 不锈钢管

And 和

19,345 Hundred meters

Stair railings 楼梯栏杆

Business all over 业务遍布

86 regional markets

86 个地区市场

The above data is as of November 2019
以上数据截止于 2019 年 11 月



- 1 Malaysia
- 2 Singapore
- 3 Thailand
- 4 Brazil
- 5 New Zealand
- 6 U.S.A
- 7 Germany
- 8 Italy
- 9 Indonesia
- 10 India
- 11 Japan
- 12 Sri Lanka
- 13 South Africa
- 14 Egypt
- 15 Algeria
- 16 Ethiopia
- 17 Ukraine
- 18 Russia
- 19 France
- 20 Lebanon
- 21 Iran
- 22 Pakistan
- 23 Australia
- 24 Brunei
- 25 Holland
- 26 United Kingdom
- 27 Turkey
- 28 U.A.E
- 29 Jordan
- 30 Cyprus
- 31 Saudi Arabia

E-PAI MANUFACTURING

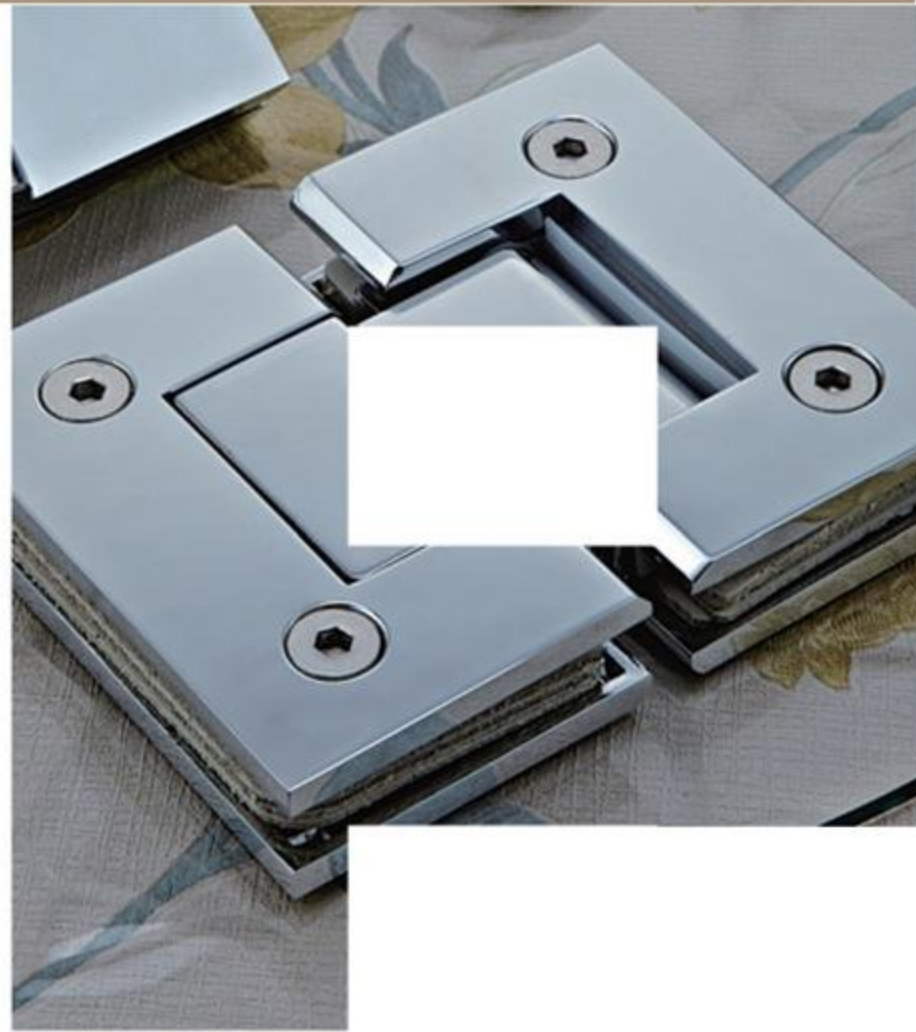

Superior materials: quality begins at the source

Expertise on stainless steel products 1

WHY DO WE NEED TO USE SPECIAL QUALITY PIPES TO PRODUCE OUR DOOR HANDLES AND BALUSTRADES

Robust and convenient packaging

In order to allow customers to get the steel pipe, the use is more convenient, the product is not damaged, we have done a lot of research work to ensure. From the beginning of the production of the pipe, we have conducted a special study in consideration of every link in the installation of the railing. This is a problem that we pay special attention to, to ensure the production of qualified quality products, the bad factors caused by packaging, the collisions caused by short-distance transportation, and the problems arising from shipping, etc., comprehensively considering the combination of product quality and cost, and finally got the most Good packaging method:

- **Each tube is placed inside a plastic sleeve.**

The plastic sleeve is the whole production, not the disjointed splicing. The tube is well protected in the plastic sleeve and there are no unnecessary scratches, so that you get the perfect ideal tube.

- **The package can withstand all kinds of bad weather such as rain, frost, snow and heat.**

On rainy days, the tube can be hidden, no further packaging is required, the package is taken out of the package, dried with a cloth and dried properly, and it can be processed immediately.

- **Our packaging**

Unlimited storage in dust, dirt, and oil felt environments. Although the exterior of the package is dirty, when you peel off the cartridge, it will shine like a new one without wiping the surface. Although it is placed for a while, it does not affect the easy making of money.

- **Each tube is packaged in color coded**

The black mark means the "EPAI" tube and the anti-counterfeit laser stamp is attached to the tube. The red mark is the super product. The "epipes" blue mark means the 201 product, which will never make you wrong when used. The product is always your most assured product.

- **Each product has a label that you can easily identify**

Each product will have a label corresponding to the standard and requirements, and it is not easy to make mistakes when shipping to your warehouse. If you have a malicious change, please rest assured that we also have corresponding trademarks and logos on the products. Our products have excellent surface treatment and reliable packaging, so you can use them with confidence.

E-PAI MANUFACTURING



- **We can also provide the convenience of short-sized tubes for individual customers.**

There are many customers who use stainless steel pipes for stair railings and handrails, and often use short-sized stainless steel pipes. We have designed some unique suggestions to make the pipe lengths 3.8 meters and 4.3 meters. In this way, you can save your budget for purchasing projects, and it is more convenient to buy the stair railings that we have tailored for you. The standard for the pipe market is 6 meters long, so this is good for your production and sales. We also have matching railings and armrests for you to use and purchase. Therefore, you can professionally solve the problems in the design and installation of stair railings, really saving you the cost of installing the balustrade. We have a sales and production experience of 1 62 62 meters of balustrades, which will provide you with real convenience and the best price. You choose our factory to serve you, this is the most correct choice.

- **High-grade packaging**

We also offer our customers a package that is superior to their peers. We use high-grade packaging materials to wrap the product in a white, neat and safe outerwear. Our products stand out in many products, and you can easily see the high-quality stainless steel tubes that are wrapped safely.

- **Smart bale**

We use a lot of tape to hold the tubes together and ensure that the products are not deformed, so that they can be easily stored and transferred during transportation. You can easily arrange them neatly, which saves your warehouse space.

- **The innovative design of the package will take into account the convenience of carrying staff.**

We specialize in what kind of specifications, how many bundles, and can be safely shipped and placed. We have studied the number of ways that our customers can sell and use the most convenient way, even if they don't break the package, they can be sold and put into use.

- **Every nozzle we pass special treatment**

We have strict quality control and process control, and the nozzle does not occur because the chemical composition of chromium and nickel changes after cutting, which causes the edge to rust.

- **Further protection of our packaging**

According to our statistics, there are 64% of cases where the packaged packaging tape is easy to break. Therefore, we have taken care to avoid packaging damage in the medium term, so each package has an extra bandage at the top edge that effectively protects the outside from damage to the stainless steel tube and packaging.



E-Pai Manufacturing

- Making Quality Products For Almost 24 Years
- User Of Progressive PDCA Manufacturing Processes
- Mechanical And Technical Expertise Available To Assist Your Manufacturing Processes
- Strictly Contro Quality Management,We Produce Stainless Steel Pipes By Ourselves

• Excellent surface quality

We will strictly polish the handrails, although it is difficult to find scratches at a distance of 2cm. It is necessary to know that the anti-rust properties of stainless steel contain a large amount of anti-corrosive chemical elements such as chromium and nickel, and good surface treatment can also effectively enhance the corrosion resistance.

• High standard mirror finish to 800# (8K).

Our high standard finishes meet the demanding and demanding customer requirements for surface treatment. The product will look like a mirror, so you don't have to re-polish the stainless steel tube that makes the stair rails.

• Ingenious craftsmanship ensures that the weld has no hand welds and is hard to find with the naked eye.

Our special welding process, leading technology and industry level, is difficult to find with the naked eye, and has a comfortable and comfortable feel.

• Confident and firm luster

Our 8K series stainless steel tubes are truly mirror-finished, the highest standard in the industry, with brightness and finish really reaching 800#. Please note that this is not chrome plating, but the results of our many years of production experience and a large number of experiments, and really do it for you.

• How does EPAI regulate the marking of stainless steel pipes?

《Prima》 the corresponding product is Aisi201

《Super》 the corresponding product is Aisi304

《Ultra》 the corresponding product is Aisi316L

• For the thickness identification of stainless steel tubes:

- 《5》 -Such as pipe thickness 2mm, prima5, super5, Ultra5;
- 《4》 -Such as pipe thickness 1.7mm, prima4, super4, Ultra4;
- 《3》 -Such as pipe thickness 1.5mm, prima3, super3, Ultra3;
- 《2》 -Such as pipe thickness 1.35mm, prima2, super2, Ultra2;
- 《1》 -Such as pipe thickness 1.2mm, prima1, super1, Ultra1;
- 《0》 -Such as pipe thickness 1.0mm, prima0, super0, Ultra0;

• For the definition of the quality of stainless steel tube polishing:

- 《+》 Premium polishing method, 800# level;
- 《-》 Conventional polishing method, 600# level;
- 《—》 Degraded polishing method, 500# level;

For example: the diameter is 16 round tubes, the material is AISI316L, the wall thickness is 1.5 thick, and the surface treatment is 600#.

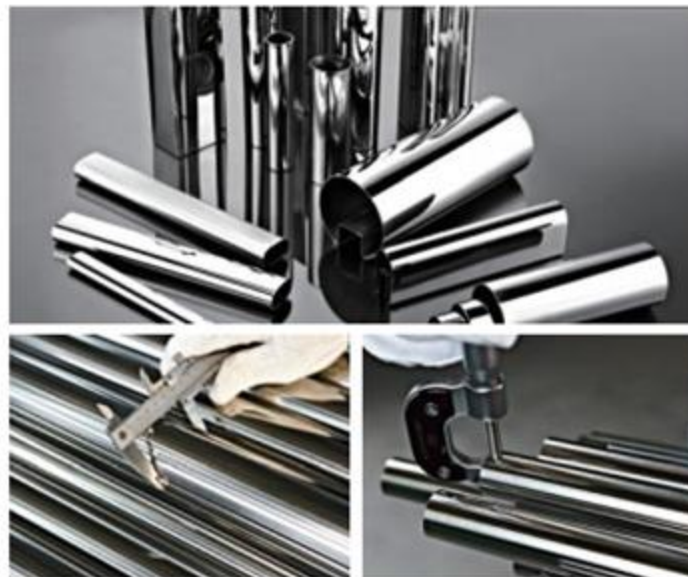

Shipping Mark: OMH Item Name: SUPER 3 Material: SUS304 Finish: PSS Size: 10*30*1.5 Length: 6000mm Total N.W: 填每扎净重 Kgs Total G.W: Kgs Total QTY: 填每扎支数 pcs	Shipping Mark: OMH Item Name: Ultra 1 Material: SUS304/SUS316 Finish: SSS Size: 10*30*1.2 Length: 6000mm Total N.W: 填每扎净重 Kgs Total G.W: Kgs Total QTY: 填每扎支数 pcs
--	---

30*10 亮光外标签

30*10 砂光外标签

QUALITY CONTROL OF PARTS OF THE PRODUCT



Strictly implement the quality management system "ISO9001-2015"

Each product is manufactured by EPAI to ensure that each product is qualified to meet customer needs. The company's development process and production process are controlled by the strict quality management system "ISO9001-2015" quality system. Over the years, a large number of spare parts have been put into the stainless steel railing project, which has been recognized by customers and can quickly occupy the market position. Can prove this.

It is no secret that most of the world's most cost-effective products are manufactured in China. We have absorbed the technology of Western countries such as Germany and tried to produce the highest quality products. When we are in the production process, most of our products are exported to all parts of the world, while some foreign quality requirements and correct internal control systems are also guided by these trained professionals in a high standard, we extract 4 important methods and stages of product quality control;

• Do a good job in incoming inspection;

Each batch of products is analyzed by precision spectroscopic analysis at the beginning of production, and then put into the workshop after meeting the requirements. This is a very important link that plays a fundamental role in quality control throughout the production process. We will conduct a quality assessment of 10 suppliers and select 2 suppliers that can meet all of our requirements. They will never neglect the quality requirements for the sake of cheapness. Only with the common values of product quality can we become our qualified suppliers.

• Inspect the inspection work of each process strictly in the production process.

In the production process, the thickness and diameter of the product are strictly controlled, and strict matching is required for some matching components. If you are responsible for the product parts in the technical details, we will collect all the sample parts and components for trial installation, and even set up and test the actual 1:1 scene to ensure that the product can be easily used and installed in the hands of the customer.

For example, if the customer wants to make a glass spiral staircase, we will build a two-layer model on site with the customer's request, and perform metal and glass railings according to the actual situation to ensure that it can be installed on site. And test the pressure to ensure that the glass's pressure resistance is qualified and safe.

• We will control the quality 100% before the production is completed.

Every detail of the product will be checked by the final quality before packaging. We also do 100% inspection of important products. The conventional practice is that we will take 0.1% of the volume per batch or 1% of the sampling, but at least not less than 10 different boxes from 10 to extract the box, there is no empty space. The working specification for the sampled product is to check the size tolerance of the product, the state of the component, and so on. At least one product should be subjected to a chemical composition analysis review for each batch of goods. If any problems are found, a review component analysis will be arranged for each product.

• Products enter the warehouse - for final control

Before shipment, we will also conduct random inspections on the products to ensure the results of the first three quality control: the integrity of the packaging, the label of the whole box, to ensure that every link is guaranteed and recorded. All the records prove that we have done this work well in the past 5 years. According to our understanding, no one in the country asks for this. It is worth noting that you do not see these costs reflected in the quotation of the product, the quality product you get is only the base price of a product.



Expertise on stainless steel products 2

WHY DO WE NEED TO USE SPECIAL QUALITY PIPES TO PRODUCE OUR DOOR HANDLES AND BALUSTRADES?

The ideal material for the production of stainless steel door handles and stair railings, we use the best metal materials

Can stainless steel be truly rust-proof and corrosion-resistant?

Chromium is the main element determining the properties of stainless steel. We add chromium as an alloying element to steel to effectively enhance the corrosion resistance of steel. The role of nickel as an alloying element in stainless steel changes with the structure of high-chromium steel, thus making stainless steel Corrosion resistance is improved. EPAI stainless steel tubes are fully compliant and above international standards, so we use the best stainless steel materials for our products.

Does the stainless steel tube burst when it is bent and shaped?

In more than 20 years of production experience, EPAI has conducted intensive research on stainless steel and is well aware of its structure and composition. And the experience source is used to produce stainless steel pipe technology, making the plastic performance of the EPAI stainless steel pipe superior to the peer products. Therefore, we will ensure that the quality of pipes and products are superior to those of our peers, leading the industry to a high level.

Corrosion, special circumstances can also occur, such as high concentration of acid and alkali washing liquid, contamination with construction cement slurry, penetration of welding iron slag and point defects of products, etc., some of which may cause corrosion when the product is not well protected.

Also, a good polished surface is much more resistant to corrosion than a bad polished surface.

Stainless steel AISI 316 316 stainless steel is a kind of stainless steel. Due to the addition of Mo element, it has a great improvement in corrosion resistance and can be used under harsh conditions. UNTRA stainless steel common pipes, balustrades in coastal areas and materials used outside the building.
UNTRA (AISI316L) European standard: 1.4404 Chinese standard: 022Cr17Ni12Mo2

Stainless steel AISI 304 304 stainless steel is a common material in stainless steel with a density of 7.93 g/cm³, also known as 18/8 stainless steel. It has the characteristics of good processing performance and high toughness, and is widely used in industrial and furniture decoration industry and food medical industry. Building decoration materials such as stair railings are widely used in places where the requirements of the World Health Organization are required.
SUPER (AISI304) European standard: 1.4301 Chinese standard: 06Cr19Ni10

Stainless steel AISI 201 201 stainless steel, with a certain acid and alkali resistance. Mainly used for decorative tubes, industrial tubes, some shallow stretched products. The balustrades are adapted to dry indoors and clean places, such as classrooms, classrooms, and conference rooms.
PRIMA (AISI201) European standard: 1.4372 Chinese standard: 12Cr17Mn6Ni5N

Standard chemical formula



Most Of Our Products Are Made Of High Quality Stainless Steel.
We Are The Only Manufacturer In China That Has Raw Material Production And Supply.
Our Technology And Service Are Ahead Of Our Peers!

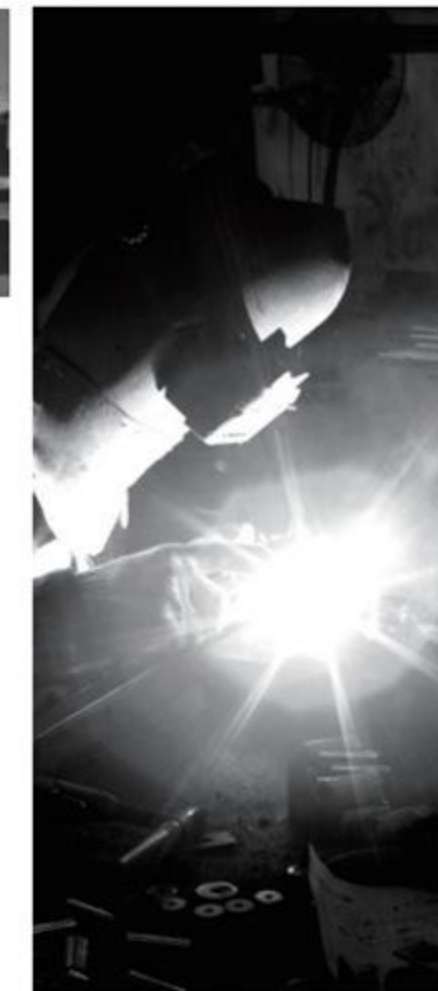

MACHINE SHOP
COVERS AN AREA OF 30000 SQUARE METERS AND 22000 SQUARE METERS OF BUILDING

ODM&OEM

Any kinds of **Architectural Hardware**